

# Architectural Door Accessories

**ASSA ABLOY**  
Opening Solutions

Experience a safer  
and more open world

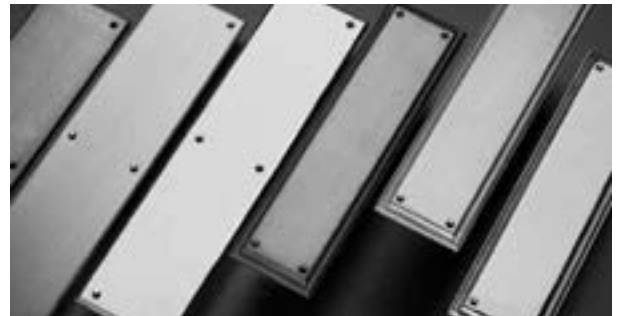
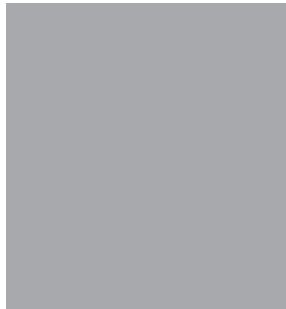
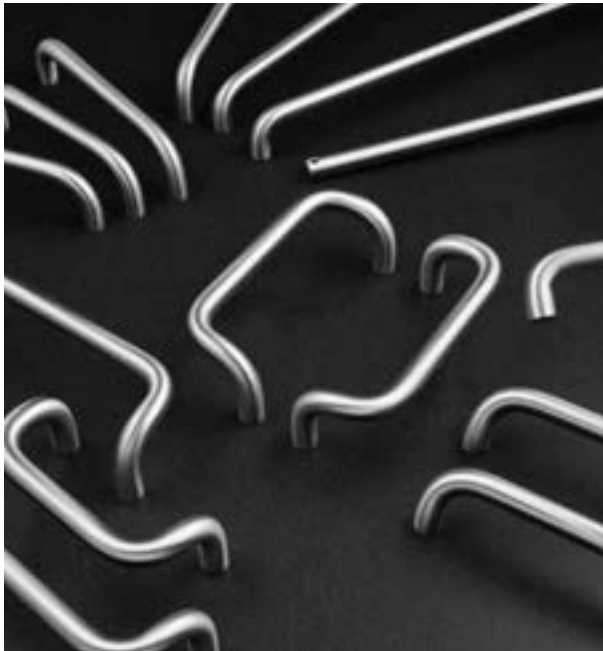
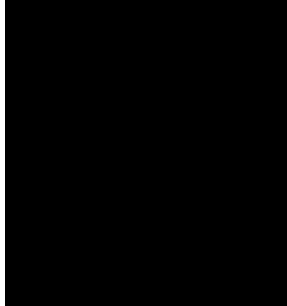
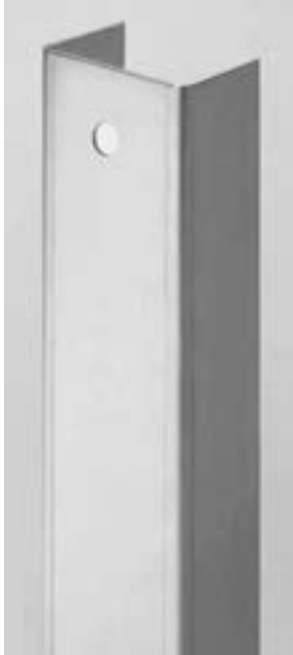

## Rockwood Products Price Book - Accessories

USA & Canada Prices Effective May 1, 2021

Surcharge of 15% will be applied to products within this price list book effective July 12, 2021.



Table of Contents	Page #
Architectural Finishes	33
Angle Plates	29
Auxiliary Hardware	27
Card Holder	25
Coordinators	27
Corner Guards	21
Covers	28
Custom Strikes	29
Decals	25
Door Edges	21-22
Door Guards	25
Door Knockers & Viewers	25
Door Plates - Kick Plates/Armor Plates	30-32
Door Pulls	16-20
Door Silencers	25
Door Stops	23-24
Fasteners - Spare Parts	38-41
Filler Plates & Shims	29
Flush Bolts	27
Flush Bolts - Manual	24
Flush Pulls	15
Gate Latch	24
Gravity Door Coordinators	24
General Information	8
Hands Free Pulls	19
Latch Protectors	22
Mounting Details	34-37
Mounting Kits	42
Numeric Index	4-7
Overhead Holders & Stops	28
Pivots	29
Privacy Door Latch	25
Pull Plate Sets	14
Pull Plates	20-21
Push and Pull Bars	9
Push Plate Ordering Information	12
Push Plates	13-15
Roller Latches	24
Series 47 Push Bars	10
Series 47 Tubular Push & Pull Bars	11
Signs	26
Surface Bolts	24-25
Trim Protector Bars	29
Vandal Resistant Trim & Vandal Resistant Pulls	20
Wall Guard	25

# ROCKWOOD

USA: 800-458-2424 | www.assaabloydooraccessories.us  
 Canada: 800-461-3007 | www.assaabloydss.ca

Check the websites for the most updated product information.

No.	Description	Page	No.	Description	Page
10-PB	Push Bar .....	9	96	Flush Pull .....	15
10BO	Bracket for #10 .....	9	102-RKW	Straight Door Pull .....	16
11-PB – 18-PB	Push Bars .....	9	102 x 70	Pull Plates .....	20
19-PB	Push Bar .....	9	105	Straight Door Pull .....	16
20-PB – 23-PB	Pull Bars .....	9	105 x 70	Pull Plates .....	20
25-PB – 26-PB	Push Bars .....	9	106-RKW	Straight Door Pull .....	16
27-PB – 30-PB	Push Pull Bar Sets .....	9	106 x 70	Pull Plates .....	20
31-PB – 32-PB	Pull Bars .....	9	107	Straight Door Pull .....	16
33-PB – 34-PB	Push Bars .....	9	107 x 70	Pull Plates .....	20
35-PB – 36-PB	Push Pull Bar Sets .....	9	107 x 73B/73BL	Pull Plate Set .....	14
40-PB – 42-PB	Screen Door Guards .....	9	108 – 110-RKW	Straight Door Pull .....	16
43-PB – 45-PB	Push Bars .....	9	110 x 70	Pull Plates .....	20
47-PB, -2-PB, -3-PB	Series 47 Push Bars .....	10	110 x 73C/73CL	Pull Plate Set .....	14
48-PB	Series 47 Push Bar .....	10	110-6SP	Security Door Pull .....	16
50-PB	Pull Bar .....	9	111, 111A	Straight Door Pull .....	16
51-PB	Push Bar .....	9	111 x 70	Pull Plates .....	20
51BO	Bracket for #50 .....	9	111 x 73C/73CL	Pull Plate Set .....	14
52-PB	Push Pull Bar Set .....	9	112	Straight Door Pull .....	16
53-PB	Push Pull Bar Set .....	9	118	Straight Door Pull .....	16
70 Series	Push Plates - .050" Thick .....	13	120 – 122-RKW	Door Pulls .....	17
71 Series	Push Plates - .062" Thick .....	13	122 x 70	Pull Plates .....	20
73 Series	Push Plates - .125" Thick .....	14	123	Door Pull .....	17
75 Series	Push Plates - .125" Thick .....	14	123 x 70	Pull Plates .....	20
76 Series	Decorative Push Plates - .050" Thick .....	14	125-RKW	Door Pull .....	17
77 Series	Decorative Push Plates - .050" Thick .....	14	125 x 70	Pull Plates .....	20
80 – 86	Push Plates - .050" Thick .....	15	126-RKW	Door Pull .....	17
87	Push Plate - .125" Thick .....	15	126 x 70	Pull Plates .....	20
90, 90B	Cylinder Pulls .....	15	130-RKW – 132-RKW	Cast Door Pulls .....	17
91-RKW – 93-RKW	Combination Push Pull Plates .....	15	132 x 70	Pull Plates .....	20
94, 94BTB	Flush Pulls .....	15	134-RKW – 137	Cast Door Pulls .....	17
94C	Flush Pull .....	15	137 x 70	Pull Plates .....	20
94DLL, 94DLS	Dead Lock Flush Pulls .....	15	138 – 139	Cast Door Pulls .....	17
94L, 94P	Flush Pulls .....	15	147, 147L	Cast Door Pulls .....	17
94P x 94L	Flush Pull Set .....	15	147 x 76, 77	Decorative Pull Plates .....	21
95A, 95B	Flush Pulls .....	15	148	Cast Door Pull .....	17
95R	Flush Pull - Round .....	15	148 x 76, 77	Decorative Pull Plates .....	21

No.	Description	Page	No.	Description	Page
149	Cast Door Pull.....	17	488 – 489	Door Stops.....	24
176-RKW – 177	Offset Door Pulls.....	19	490	Door Holder & Stop.....	24
185	Offset Door Pull.....	19	491-RKW – 494S	Automatic Door Holders & Stops.....	24
193	Hospital Door Pull.....	19	495	Concealed Magnetic Door Stop.....	24
208	Wooden Door Pull.....	19	505-RKW – 508	Cast Brass Door Stops.....	24
215, 215L	Tapered Door Pulls.....	19	517	Aluminum Door Stop.....	24
290 – 296	Corner Guards.....	21	518 – 519	Cast Brass Door Stops.....	24
300 – 302B	Mortise Door Edges.....	21	520	Replacement Bumper.....	24
304 – 307	Non-Mortise Door Edges.....	22	525 – 526	Spring Base Door Stops.....	24
308 – 310B-BS	Overlapping Door Edges.....	22	528	Hinge Pin Stop.....	24
320-RKW – 330	Latch Protectors.....	22	550 Series	Lever Ext. Flush Bolt, Guide & Strike.....	24
400 – 405	Solid Cast Wall Stops.....	23	554 Series	Rabbet Piece, Guide & Strike.....	24
406 – 409	Wrought Wall Stops.....	23	555 Series	Lever Ext. Flush Bolt, Bolt Head, Guide & Strike.....	24
412 – 416	Solid Cast Wall Stops.....	23	555ROD	Optional Bolt Lengths.....	24
426	Wall Stop.....	23	555 x BFB	Flush Bolt w/Bottom Fire Bolt.....	24
430-RKW	Solid Cast Wall Stop.....	23	556WS	Lever Ext. Wind Storm Flush Bolt.....	24
431-RKW, 432W	Wall Stops.....	23	557 Series	Lever Ext. Flush Bolt & Strike.....	24
440 – 441	Low Dome Stops.....	23	570	Dust Proof Strike.....	24
441CU	Dome Stop Combination Unit.....	23	576, 576B	Gravity Door Coordinator.....	24
441H	Cast Universal Dome Stop.....	23	580 Series	Surface Bolts.....	24
442 – 443	High Dome Stops.....	23	582 Series	Surface Bolts.....	24
444	Cast Door Stop Riser.....	23	585 Series	Heavy Duty Surface Bolts.....	24
445, 445H	Heavy Duty Door Stops.....	23	590 – 594	Roller Latches.....	24
446	Door Stop.....	23	602	Secret Gate Latch.....	24
449	Door Stop Riser.....	23	603 – 604 Shim	Door Guards w/Shim.....	25
455	Curved Roller Stop.....	23	605, 605SMS	Door Guard Protection Plates.....	25
456-RKW, 456L	Straight Roller Stops.....	23	606-RKW	Wall Guard.....	25
458	Kick Down Door Stop.....	23	PDLAA	Privacy Door Latch.....	25
459	Spring Loaded Plunger Stop.....	23	608-RKW – 609	Door Silencers.....	25
460 – 461L	Kick Down Door Stops.....	23	611	Door Knocker.....	25
462 – 468-RKW	Heavy Duty Door Stops.....	23	614, 614V	Door Knockers.....	25
470 – 481	Door Stops.....	23	619	160° Door Viewer.....	25
481MP	Heavy Duty Mounting Plate.....	23	620	160° Door Viewer.....	25
482 – 485	Door Stops.....	23	620VC	Viewer Cover for 619.....	25
486	Angle Door Stop.....	23	621	160° Door Viewer.....	25
487	Heavy Duty Wall Stop.....	23			

No.	Description	Page	No.	Description	Page
622	190° Door Viewer .....	25	2960, 2962	Automatic Flush Bolts .....	27
622VC	Viewer Cover for 622 .....	25	11047, -2, -3	Straight Push Pull Bar Sets .....	10
624	160° Door Viewer w/Cover .....	25	11147, -2, -3	Straight Push Pull Bar Sets .....	10
626 – 629	190° Door Viewers w/Cover .....	25	111A47, -2, -3	Straight Push Pull Bar Sets .....	10
630 Series	Surface Bolts .....	25	11247, -2, -3	Straight Push Pull Bar Sets .....	10
651	Card Holder .....	25	11847	Straight Push Pull Bar Set .....	10
660, 661, 662-RKW	Decals .....	25	AP1007 – AP1141	Arm Pulls.....	19
670 Series	Engraved Signs.....	26	BF97, BF97L	Barrier Free Flush Pulls.....	15
674H, 674L	Engraved Signs.....	26	BF150 – BF159	90° Offset Door Pulls .....	18
700 – 702	Hand Rail Brackets.....	27	BF156 – BF159 C17	90° Offset Door Pull Sets.....	18
790	Small Coat Hook.....	27	BF160 – BF169	45° Offset Door Pulls .....	19
796	Small Double Coat Hook.....	27	BF257 – BF260	Heavy Duty Offset Door Pulls.....	20
802, 806	Medium Coat Hooks .....	27	BF680 Series	Engraved Signs w/Braille.....	26
841	Ball Knob.....	27	BF683 – BF689	ADA Tactile Signs w/Braille .....	26
845	Utility Pull.....	27	BF15647, -2, -3	Offset Push Pull Bar Sets .....	10
850 – 856-RKW	Wire Pulls.....	27	BF15747, -2, -3	Offset Push Pull Bar Sets.....	10
860	Flush Cup Pull.....	27	BF157A47, -2, -3	Offset Push Pull Bar Sets.....	10
870	Wrought Flush Pull .....	27	BF15847, -2, -3	Offset Push Pull Bar Sets.....	10
872	Cast Flush Pull .....	27	BF15947	Offset Push Pull Bar Set .....	10
880	Cast Lever Edge Pull.....	27	BFLG10 – BFLG16	Latch Guard Covers .....	28
885-RKW	Concealed Edge Pull.....	27	BFM624, BFM625	All Gender Restroom Signs .....	26
890 – 891	Pocket Door Pulls .....	27	BFM682 – BFM689	Tactile ADA Molded Plastic Signs w/Braille.....	26
900 – 901	Magnetic Catches.....	27	BFRC12, BFRC24	Vertical Rod Covers .....	28
910 – 911	Adjustable Ball Catches .....	27	BP47, -2, -3	Series 47 Push Bars w/Base Plate.....	10
1100	Carry Bar .....	27	CP10 – CP10HD	Pivots - Standard Head .....	29
1700	Door Coordinator .....	27	CP40 – CP40HD	Pivots - Standard Floor .....	29
2600 Series	Door Coordinators .....	27	CPK2840	Cover Plate Kit .....	27
2805	Self Latching Flush Bolt (Top Only).....	27	CS Series	Custom Strikes .....	29
2840, 2842	Automatic Flush Bolt Sets.....	27	D89	Security Flush Pull .....	15
2845	Combination Flush Bolt Set .....	27	D133-RKW	Security Loop Door Pull.....	17
2848, 2849	Flush Bolts w/Bottom Fire Bolt .....	27	DF86	Door Edge Filler Plate.....	29
2905	Self Latching Flush Bolt (Top Only).....	27	DFF4	Frame Hinge Filler Plates .....	29
2940, 2942	Automatic Flush Bolt Set.....	27	DFF5	Frame Hinge Filler Plates .....	29
2945	Combination Flush Bolt Set .....	27	DHF4B	Door Hinge Filler Plates .....	29
2948, 2949	Flush Bolts w/Bottom Fire Bolt .....	27			

No.	Description	Page	No.	Description	Page
DHF4S	Door Hinge Filler Plates .....	29	R101LPB	Trim Protector Bars.....	29
DHF5B	Door Hinge Filler Plates .....	29	R102LPB	Trim Protector Bars.....	29
DHF5S	Door Hinge Filler Plates .....	29	R111LPB	Trim Protector Bars.....	29
FB-1, -2	Filler Bars.....	27	R112LPB	Trim Protector Bars.....	29
FBF48	Flush Bolt Filler Plate .....	29	R115LPB	Trim Protector Bars.....	29
FBS48	Flush Bolt Strike Filler Plate .....	29	R116EDPH	Exit Device Protector .....	29
FC161	Door Face Filler Plate.....	29	R116EDPL	Exit Device Protector .....	29
FD160	Door Face Filler Plate.....	29	SD1230	Standard Duty Trim Protector Bar.....	29
FP1230	Foot Pull .....	19	SD1240	Standard Duty Trim Protector Bar.....	29
HD2230	Heavy Duty Trim Protector Bars .....	29	SD1250	Standard Duty Trim Protector Bar.....	29
HD2240	Heavy Duty Trim Protector Bars .....	29	SD1260	Standard Duty Trim Protector Bar.....	29
HD2250	Heavy Duty Trim Protector Bars .....	29	SF160	Strike Filler Plate .....	29
HS42	4 Hinge Shims .....	29	SFASA	Strike Filler Plate .....	29
HS44	4 ½" Hinge Shims .....	29	SFB160	Strike Filler Plate .....	29
HS52	5" Hinge Shims .....	29	SP47	Series 47 Push Bar .....	10
HS54	5" Hinge Shims .....	29	SP1001 – SP1079	Fasteners - Spare Parts .....	38-41
K1038	Metal Door Plate - .038" Thick.....	31	T47, -2, -3	Tubular Push Bars .....	11
K1050, K1050F	Metal Door Plates - .050" Thick.....	31	T110 – T118	Tubular Door Pulls .....	16
K1050-1 – K1050-8	Shaped Metal Door Plates - .050" Thick.....	31	T110 x 70	Tubular Pull Plates .....	21
K1050A-1 – K1050A-8	Shaped Metal Door Plates - .050" Thick.....	31	T111 x 70	Tubular Pull Plates .....	21
K1062	Metal Door Plate - .062" Thick.....	31	T11047	Tubular Straight Push Pull Bar Sets.....	11
K1125	Metal Door Plate - .125" Thick.....	31	T11147	Tubular Straight Push Pull Bar Sets.....	11
K2060 Series	Plastic Door Plates - .060" Thick.....	31	T111A47	Tubular Straight Push Pull Bar Sets.....	11
K2125 Series	Plastic Door Plates - .125" Thick.....	31	T11247	Tubular Straight Push Pull Bar Sets.....	11
K3125	Laminate Plastic Door Plate - .125" Thick.....	31	T11847	Tubular Straight Push Pull Bar Set.....	11
K4125	Clear Plastic Door Plate - .125" Thick.....	31	TBF156 – TBF159	Tubular 90° Offset Door Pulls .....	18
KB1150 – KB1152	Angle Plates - .050" Thick .....	29	TBF156 – TBF159 C17	Tubular 90° Offset Door Pull Sets .....	18
KIT Series	Mounting Kits for Door Pulls .....	42	TBF15647	Tubular Offset Push Pull Bar Sets.....	11
LA86	Latch Adapter Plate.....	29	TBF15747	Tubular Offset Push Pull Bar Sets.....	11
LF161	Door Edge Filler Plate.....	29	TBF157A47	Tubular Offset Push Pull Bar Sets.....	11
OH100	HD Concealed Overhead Stops.....	28	TBF15847	Tubular Offset Push Pull Bar Sets.....	11
OH200	Concealed Overhead Holders & Stops .....	28	TBF15947	Tubular Offset Push Pull Bar Set.....	11
OH900	HD Surface Overhead Stops .....	28	VRP30	Vandal Resistant Pull.....	20
OH1000	Surface Overhead Holders & Stops.....	28	VRT12 – VRT26	Vandal Resistant Trim .....	20
PDLAA	Privacy Door Latch .....	25			

## Ordering Information

This price list cancels and supersedes all prior listings.

Orders are accepted with the understanding that they will be billed at prices in effect at time of shipment.

Prices are subject to change without notice.

We reserve the right to decline the whole or part of orders in which the price or quantity of goods is not acceptable to us.

## Easy Order Placement

### USA:

By Phone: 1-800-458-2424 Monday through Thursday 8:00 am ET to 7:30 pm ET, Friday 8:00 am ET to 4:30 pm ET

By Fax: Orders may be faxed to 1-800-922-9212

By Email: orders.rockwood@assaabloy.com

By Internet: <http://extranet.assaabloydss.com/> and select Order Entry under the Customer Service Menu

### Canada:

By Phone: 1-800-461-3007 Monday through Friday 8:00 am ET to 4:30 pm ET

By Fax: Orders may be faxed to 1-800-461-8989

By Email: [cavau-orders@assaabloy.com](mailto:cavau-orders@assaabloy.com)

By Internet: <http://extranet.assaabloydss.ca/> and select Order Entry under the Customer Service Menu

## Terms and Conditions of Sale

Terms: 1% 15 days, net 30 days

Remit Payment To: PNC Bank/Rockwood, PO Box 644489, Pittsburgh, PA 15264-4489

For Terms & Conditions and Warranty information pertaining to product sales in Canada, please visit [www.assaabloy.ca/terms](http://www.assaabloy.ca/terms)

## Freight Policy

Freight Allowance: All prices are F.O.B. Rockwood, Pennsylvania and/or Ventura, California. Full freight will be allowed on shipments of \$1,250 net and over within the continental limits of the United States. All shipments are routed most cost effective route of our choice. We reserve the right to designate the carrier.

## Special Order Material

Special items made to your specifications are not returnable. These items are not subject to cancellation without consideration of expense involved at the cancellation date.

## Samples

Salable samples will be charged at regular prices.

## Returned Goods

Return no merchandise without written permission from the factory. Authorization will insure your receiving proper credit. Errors in shipping may occasionally occur. If this is the case immediately notify the factory, and we will gladly make the proper adjustments. If the error is at the customer's end, a minimum charge of 25% plus freight will be incurred for handling. Unauthorized claims for labor or charges will not be allowed. No credit will be allowed beyond six months after invoice date.

## Shortages

Claims for shortages must be made within 30 days of invoice date.

## Templates

Upon request we will furnish templates for any of our standard items of manufacture. Commonly used templates are available on our website at [www.assaabloydooraccessories.us](http://www.assaabloydooraccessories.us).

## Product Weight Information

NOTE: Weights indicated throughout the price list are approximate for brass, bronze or stainless steel base material. Aluminum base materials weigh approximately  $\frac{1}{3}$  the listed weights.

## Engraving

Engraving may be added on many pulls and plates. Call factory for pricing.

**For Terms and Conditions as well as Warranty information pertaining to product sales in Canada, please visit [www.assaabloy.ca/terms](http://www.assaabloy.ca/terms)**



**Push and Pull Bars**

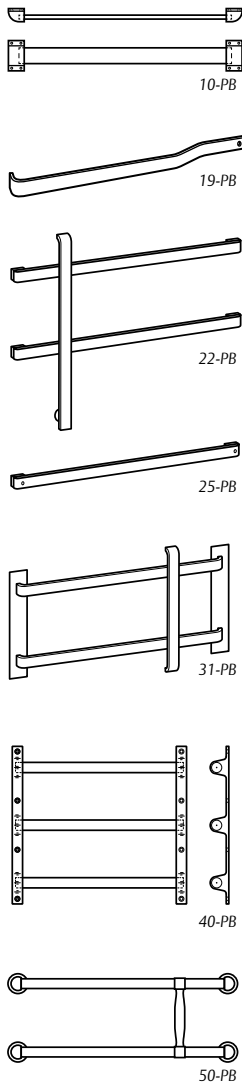

Push and Pull Bars							
Part	28/628	3/605 4/606	10/612 10B/613	10BE/BSP	26/625 26D/626	32D/630	32DMS
10-PB		461.00	461.00	466.00	445.00		
10BO		146.00	146.00	150.00	144.00		
11-PB	181.00	380.00	434.00	236.00	420.00	191.00	203.00
12-PB	181.00	380.00	434.00	236.00	420.00	191.00	203.00
14-PB	181.00	434.00	486.00	259.00	472.00	207.00	221.00
15-PB	181.00	434.00	486.00	259.00	472.00	207.00	221.00
18-PB	181.00	434.00	486.00	259.00	472.00	207.00	221.00
19-PB	181.00	434.00	486.00	259.00	472.00	207.00	221.00
20-PB	443.00	998.00	1,161.00	567.00	1,124.00	456.00	468.00
21-PB	502.00	1,077.00	1,321.00	632.00	1,282.00	506.00	521.00
22-PB	510.00	1,133.00	1,292.00	654.00	1,254.00	524.00	537.00
23-PB	542.00	1,215.00	1,455.00	687.00	1,413.00	550.00	563.00
25-PB	174.00	380.00	434.00	205.00	420.00	163.00	176.00
26-PB	181.00	406.00	486.00	215.00	472.00	171.00	186.00
27-PB	781.00	1,751.00	2,020.00	976.00	1,960.00	782.00	794.00
28-PB	861.00	1,886.00	2,291.00	1,060.00	2,224.00	822.00	862.00
29-PB	852.00	1,967.00	2,154.00	1,060.00	2,090.00	848.00	862.00
30-PB	901.00	2,020.00	2,425.00	871.00	2,352.00	892.00	905.00
31-PB	444.00	1,074.00	1,199.00	709.00	1,164.00	566.00	581.00
32-PB	468.00	1,095.00	1,228.00	727.00	1,191.00	581.00	595.00
33-PB	385.00	852.00	955.00	554.00	928.00	443.00	458.00
34-PB	408.00	885.00	992.00	571.00	961.00	458.00	471.00
35-PB	658.00	1,925.00	2,150.00	1,263.00	2,088.00	1,012.00	1,024.00
36-PB	675.00	1,978.00	2,214.00	1,298.00	2,164.00	1,037.00	1,051.00
40-PB		400.00	400.00	363.00	387.00		
41-PB		283.00	283.00	258.00	274.00		
42-PB		205.00	205.00	186.00	198.00		
43-PB	206.00	635.00	759.00	458.00	736.00	366.00	380.00
44-PB	191.00	593.00	712.00	432.00	690.00	346.00	359.00
45-PB	179.00	538.00	645.00	408.00	625.00	327.00	339.00
50-PB		530.00	580.00	528.00	561.00		
51-PB		213.00	234.00	214.00	226.00		
51BO		41.00	47.00	43.00	45.00		
52-PB		948.00	1,041.00	947.00	1,011.00		
53-PB		181.00	203.00	186.00	197.00		

**Push & Pull Extra Length Bars**

Extra Length Bars						
Description	28/628	3/605 4/606	10/612 10B/613	10BE/BSP	26/625 26D/626	32D/630
Over 3/4" thru 1 1/2"	3.30	6.60	7.70	7.70	6.60	5.50
Over 1 1/2" thru 3"	4.40	8.80	9.90	10.70	8.80	7.70

Bars over 36" add per inch the following additional cost.

**Mounting Types for Push Bars 10 through 45 and 50, 51, 52**

Mounting charge included in list price.

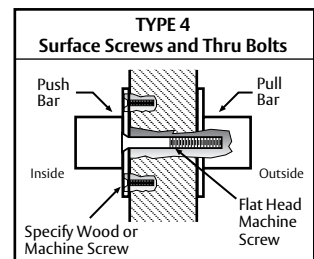
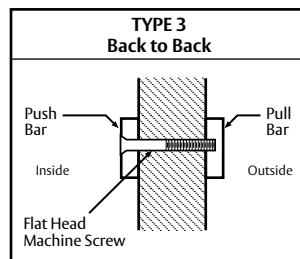
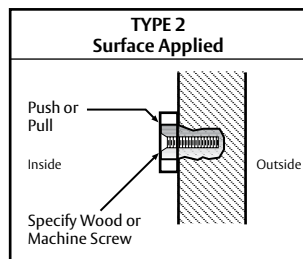
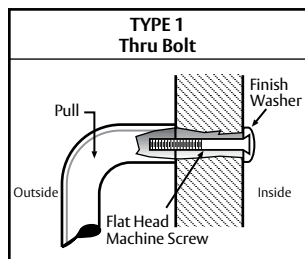

Series 47 Push Bars

Series 47 Push Bars												
Part	28/628	313/710 314 315/711	3/605 4/606	10/612 108/613	10BE/BSP	26D/626	26/625	32D/630	32/629	32DMS	32D316	32316
SP47	100.00	121.00	311.00	389.00	326.00	299.00	299.00	264.00	296.00	280.00	374.00	402.00
47-PB	61.00	68.00	245.00	322.00	296.00	242.00	252.00	160.00	184.00	283.00	378.00	396.00
47-2-PB	168.00	206.00	585.00	585.00	602.00	567.00	567.00	471.00	530.00	537.00	696.00	730.00
47-3-PB	251.00	251.00	877.00	877.00	901.00	851.00	851.00	707.00	795.00	805.00	1,042.00	1,095.00
48-PB	85.00	100.00	230.00	272.00	190.00	223.00	223.00	144.00	186.00	194.00	224.00	256.00
BP47	135.00	152.00	343.00	343.00	349.00	332.00	332.00	286.00	309.00	299.00	401.00	417.00
BP47-2	270.00	305.00	734.00	734.00	750.00	712.00	712.00	615.00	663.00	668.00	847.00	881.00
BP47-3	352.00	407.00	1,041.00	1,041.00	1,067.00	1,011.00	1,011.00	871.00	942.00	952.00	1,213.00	1,265.00
Straight Single Bar Sets												
11047	95.00	110.00	337.00	428.00	397.00	336.00	344.00	220.00	258.00	379.00	512.00	549.00
111A47	131.00	154.00	442.00	492.00	434.00	427.00	427.00	346.00	384.00	382.00	519.00	555.00
11147	97.00	111.00	348.00	442.00	409.00	343.00	355.00	227.00	264.00	393.00	465.00	528.00
11247	99.00	112.00	357.00	458.00	422.00	355.00	366.00	232.00	271.00	402.00	544.00	582.00
11847	136.00	164.00	490.00	541.00	465.00	475.00	475.00	378.00	417.00	415.00	554.00	586.00
Straight Double Bar Sets												
11047-2	146.00	166.00	542.00	1,083.00	701.00	549.00	556.00	613.00	674.00	627.00	820.00	869.00
111A47-2	177.00	208.00	640.00	1,140.00	705.00	625.00	631.00	727.00	800.00	631.00	826.00	875.00
11147-2	263.00	302.00	973.00	1,096.00	716.00	962.00	992.00	681.00	598.00	641.00	777.00	851.00
11247-2	149.00	169.00	563.00	1,110.00	725.00	557.00	574.00	626.00	688.00	650.00	851.00	901.00
Straight Triple Bar Sets												
11047-3	202.00	229.00	767.00	1,759.00	999.00	772.00	784.00	1,012.00	1,048.00	894.00	1,165.00	1,231.00
111A47-3	234.00	270.00	865.00	1,814.00	1,001.00	848.00	861.00	1,124.00	1,259.00	896.00	1,172.00	1,236.00
11147-3	320.00	363.00	1,197.00	1,774.00	1,012.00	1,187.00	1,221.00	1,016.00	1,138.00	907.00	1,123.00	1,213.00
11247-3	205.00	231.00	785.00	1,785.00	1,023.00	781.00	803.00	1,024.00	1,147.00	915.00	1,198.00	1,264.00
Offset Single Bar Sets												
BF15647	111.00	126.00	382.00	492.00	451.00	383.00	395.00	244.00	284.00	417.00	586.00	623.00
BF157A47	112.00	127.00	392.00	507.00	462.00	394.00	404.00	251.00	295.00	423.00	594.00	632.00
BF15747	112.00	127.00	392.00	507.00	465.00	394.00	404.00	251.00	295.00	423.00	594.00	632.00
BF15847	113.00	129.00	403.00	521.00	478.00	403.00	415.00	258.00	301.00	443.00	619.00	657.00
BF15947	176.00	207.00	523.00	553.00	508.00	507.00	507.00	415.00	449.00	454.00	620.00	656.00
Offset Double Bar Sets												
BF15647-2	162.00	182.00	588.00	1,147.00	742.00	587.00	605.00	648.00	713.00	663.00	890.00	940.00
BF157A47-2	162.00	182.00	588.00	1,147.00	748.00	587.00	605.00	648.00	713.00	669.00	897.00	946.00
BF15747-2	162.00	182.00	588.00	1,147.00	758.00	587.00	605.00	648.00	713.00	669.00	897.00	946.00
BF15847-2	164.00	184.00	598.00	1,160.00	767.00	609.00	614.00	655.00	720.00	687.00	918.00	971.00
Offset Triple Bar Sets												
BF15647-3	217.00	245.00	814.00	1,823.00	1,039.00	810.00	835.00	1,051.00	1,165.00	930.00	1,235.00	1,303.00
BF157A47-3	217.00	245.00	814.00	1,823.00	1,046.00	810.00	835.00	1,051.00	1,156.00	936.00	1,242.00	1,307.00
BF15747-3	217.00	245.00	814.00	1,823.00	1,053.00	810.00	835.00	1,051.00	1,156.00	936.00	1,242.00	1,307.00
BF15847-3	218.00	246.00	823.00	1,836.00	1,065.00	832.00	844.00	1,055.00	1,161.00	953.00	1,265.00	1,333.00
Series 47 Extra Length Bars - Bars over 36" add per inch the following additional cost per bar.												
	2.40	3.10	6.30	8.30	7.20	6.20	6.30	6.30	4.80	7.20	7.20	7.20

See page 35 for detailed mounting drawings. Engraving "Push" or "Pull" on 1" Series 47 Push Bars add \$103.00 (1/2" Letter Height).



47-PB

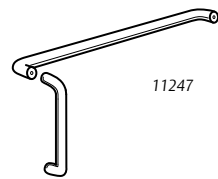

11047

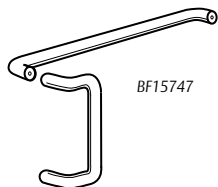

BF15747

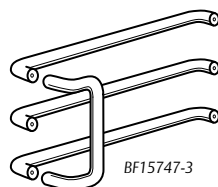

BF15747-3

Series 47 Tubular Push & Pull Bars

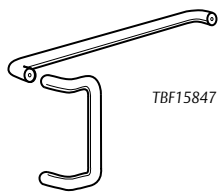
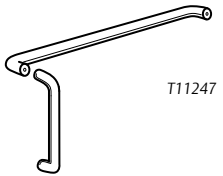

Series 47 Tubular Push Bars						
Part	3/605 4/606	10/612 10B/613	10BE/BSP	32D/630	32/629	32DMS
T47	225.00	237.00	198.00	153.00	171.00	168.00
T47-2	444.00	473.00	393.00	303.00	343.00	320.00
T47-3	668.00	706.00	590.00	456.00	513.00	470.00
Series 47 Tubular Straight Single Bar Sets						
T11047	347.00	363.00	288.00	223.00	260.00	260.00
T111A47	341.00	360.00	300.00	221.00	258.00	258.00
T11147	341.00	360.00	287.00	221.00	258.00	258.00
T11247	349.00	367.00	289.00	224.00	260.00	260.00
T11847	367.00	380.00	306.00	236.00	275.00	273.00
Series 47 Tubular Offset Single Bar Sets						
TBF15647	372.00	386.00	295.00	230.00	283.00	262.00
TBF157A47	375.00	392.00	299.00	233.00	285.00	267.00
TBF15747	375.00	392.00	299.00	233.00	304.00	267.00
TBF15847	380.00	397.00	303.00	236.00	287.00	269.00
TBF15947	400.00	419.00	324.00	252.00	304.00	286.00

See page 35 for detailed mounting drawings. Engraving "Push" or "Pull" on 1" Series 47 Push Bars add \$103.00 (1/2" Letter Height).

TYPICAL MOUNTING

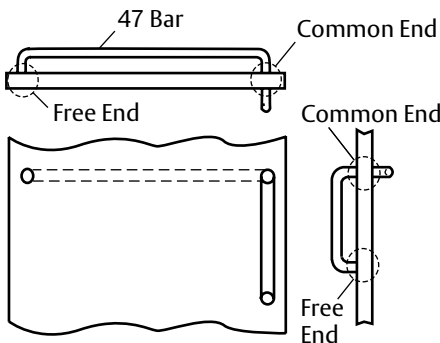

For Set Mounting Hardware, see page 34.

**Location Standards**

Positioning Applications:

- door pulls to plates
- engraving on plates
- cutouts on plates
- cutout and engraving on plates

Sizing:

- 1 1/4" standard cylinder hole cutout size
- 3/8" diameter standard thumbturn hole
- other cutout sizes and styles are readily available

NOTE: Be sure the pull you choose will fit on the plate, allowing for cutouts and/or engraving.

**Pull Positioning on Plates 4" or Less in Width**

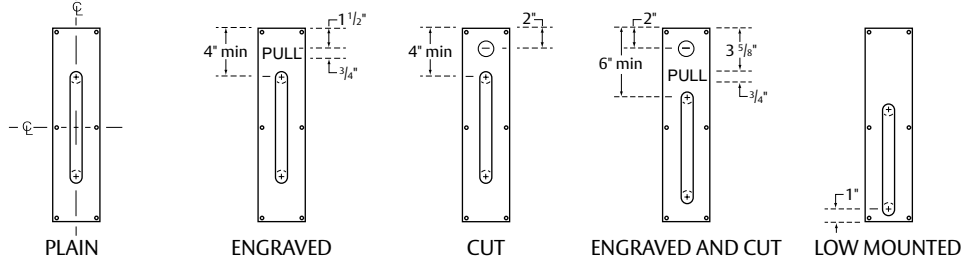

**Pull Positioning on Plates Wider than 4" (Handing Required)**

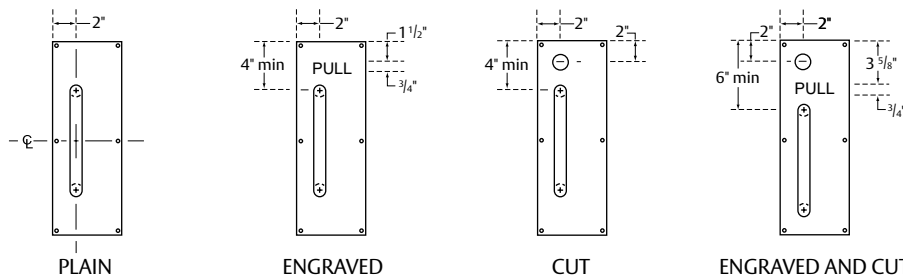

**Recommended Locations on Door**

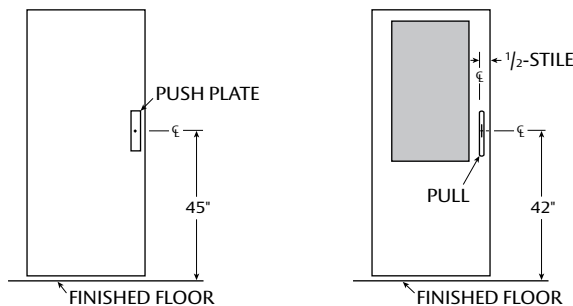

**Engraving and Adhesive Mounting**

Description	Price
Engraving "Push", "Pull", "Men" or "Women"	48.90
Push Plate Adhesive Mounting	9.80

Engraving: 3/4" high condensed block letters with black enamel fill; other letter sizes and styles are readily available.

**Additional Charges Per Thickness of Push Plate**

Part	Description	70/.050"	71/.062"	73/.125"
CFC	Cut for Cylinder	1.20	5.00	5.50
CFTT	Cut for Thumbturn	1.20	5.00	5.50
Pull Prep	Prep for Pull	2.40	10.10	10.90

Order form available when ordering.

**ADA Accessibility Guidelines for Buildings and Facilities (ADAAG)** as amended through January 1998 4.13.9 Door Hardware.

Handles, pulls, latches, locks, and other operating devices on accessible doors shall have a shape that is easy to grasp with one hand and does not require tight grasping, tight pinching, or twisting of the wrist to operate. Lever-operated mechanisms, push-type mechanisms, and U-shaped handles are acceptable designs. When sliding doors are fully open, operating hardware shall be exposed and usable from both sides. Hardware required for accessible door passage shall be mounted no higher than 48 in. (1220 mm) above finished floor.

**ASSA ABLOY**

Opening Solutions

Experience a safer  
and more open world

**Push Plates - .050" Thick**

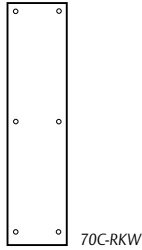

No. 70 - Square Ends										
Part	28/628	3/605 4/606	10/612 10B/613	10BE/BSP	26D/626	26/625	32D/630	32/629	32DMS	32D316
<b>70A</b>	10.20	20.00	22.40	21.10	20.00	21.20	8.30	13.10	22.70	29.70
<b>70B</b>	11.40	24.90	26.00	26.30	24.90	26.00	10.80	13.10	23.90	29.70
<b>70C-RKW</b>	14.00	28.60	31.20	28.90	28.60	30.10	10.60	15.50	26.30	32.50
<b>70E</b>	17.80	40.50	45.70	43.60	42.60	43.60	15.50	23.90	43.00	52.00
<b>70F</b>	20.40	55.00	58.00	58.00	56.00	57.00	22.70	30.00	47.90	63.00
<b>70G</b>	21.60	42.60	51.00	31.60	46.80	46.80	23.90	32.70	33.80	41.40

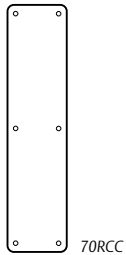

No. 70RC - Round Corners										
<b>70RCA</b>	21.60	33.80	34.80	23.60	33.80	33.80	17.90	23.90	26.30	33.60
<b>70RCB</b>	22.90	36.40	40.50	28.90	39.50	39.50	22.70	28.90	27.20	33.60
<b>70RCC</b>	22.90	40.50	45.70	31.60	44.70	44.70	25.10	31.00	28.90	36.40
<b>70RCE</b>	31.00	57.00	64.00	49.00	62.00	62.00	38.10	49.00	46.30	57.00
<b>70RCF</b>	33.00	65.00	78.00	52.00	76.00	76.00	42.00	54.00	50.00	64.00
<b>70RCG</b>	21.60	40.50	54.00	36.00	49.90	49.90	27.20	34.90	36.00	42.60

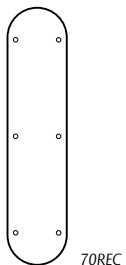

No. 70RE - Round Ends										
<b>70REA</b>	27.80	39.50	42.60	34.30	40.50	40.50	26.30	31.00	32.70	41.40
<b>70REB</b>	31.00	42.60	48.80	37.00	45.70	45.70	28.90	34.90	33.80	41.40
<b>70REC</b>	32.00	45.70	54.00	40.90	49.90	49.90	31.00	38.10	36.00	42.60

See page 12 for standard locations and sizes of Cylinder Cutouts (CFC) and Thumbturn Cutouts (CFTT), engraving and pricing.

**Push Plates - .062" Thick**

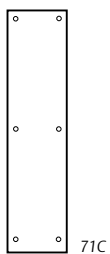

No. 71 - Square Corners			
Part	10BE/BSP	32D/630	32DMS
<b>71A</b>	30.00	23.90	38.10
<b>71B</b>	34.30	26.30	40.30
<b>71C</b>	39.20	30.00	45.20
<b>71E</b>	51.00	40.30	54.00
<b>71F</b>	60.00	46.30	61.00
<b>71G</b>	44.70	34.90	49.00

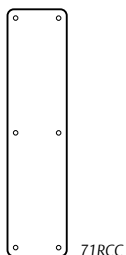

No. 71RC - Round Corners			
<b>71RCA</b>	37.00	28.90	43.00
<b>71RCB</b>	40.90	31.00	45.20
<b>71RCC</b>	44.70	34.90	49.00
<b>71RCE</b>	60.00	45.20	58.00
<b>71RCF</b>	64.00	49.00	64.00
<b>71RCG</b>	51.00	40.30	54.00

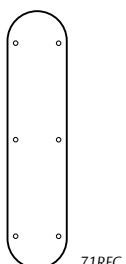

No. 71RE - Round Ends			
<b>71REA</b>	49.00	38.10	52.00
<b>71REB</b>	51.00	40.30	54.00
<b>71REC</b>	54.00	43.00	56.00

Concealed Mount Pull Plate Sets

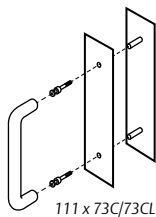

Pull Plate x Plate with Lug			
Part	32D/630	32DMS	10BE/BSP
107 x 73B/73BL	191.00	219.00	231.00
110 x 73C/73CL	251.00	288.00	304.00
111 x 73C/73CL	260.00	299.00	314.00

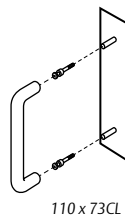

Pull (only) x Plate with Lug			
Part	32D/630	32DMS	10BE/BSP
107 x 73BL	134.00	153.00	162.00
110 x 73CL	187.00	215.00	226.00
111 x 73CL	199.00	229.00	242.00

See page 12 for standard locations and sizes of Cylinder Cutouts (CFC) and Thumbturn Cutouts (CFTT), engraving and pricing. See page 36 for detail drawing of Type 9 mounting.

Push Plates

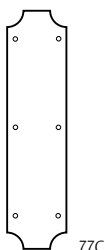
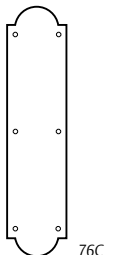
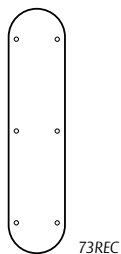
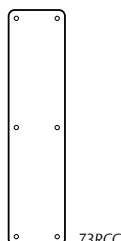
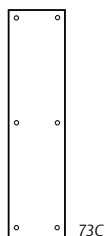

No. 73 - Square Corners (.125" Thick)									
Part	28/628	3/605 4/606	10/612 10B/613	10BE/BSP	26/625 26D/626	32D/630	32/629	32DMS	32D316
73A	33.00	89.00	104.00	65.00	101.00	50.00	73.00	66.00	76.00
73B	40.40	100.00	114.00	74.00	111.00	34.90	77.00	71.00	86.00
73C	42.00	109.00	122.00	81.00	118.00	39.20	85.00	76.00	96.00
73E	49.30	140.00	154.00	107.00	148.00	82.00	104.00	97.00	131.00
73F	57.00	177.00	190.00	131.00	183.00	100.00	119.00	116.00	147.00
73G	43.00	126.00	140.00	87.00	137.00	68.00	94.00	81.00	105.00
No. 73RC - Round Corners (.125" Thick)									
73RCA	49.30	101.00	117.00	79.00	111.00	59.00	86.00	75.00	88.00
73RCB	52.00	108.00	123.00	84.00	120.00	66.00	89.00	79.00	94.00
73RCC	55.00	121.00	135.00	89.00	128.00	72.00	100.00	86.00	105.00
73RCE	65.00	152.00	166.00	121.00	160.00	93.00	120.00	108.00	145.00
73RCF	73.00	190.00	202.00	146.00	195.00	113.00	132.00	127.00	161.00
73RCG	59.00	137.00	152.00	100.00	147.00	77.00	109.00	92.00	117.00
No. 73RE - Round Ends (.125" Thick)									
73REA	72.00	122.00	137.00	104.00	134.00	80.00	105.00	94.00	110.00
73REB	79.00	128.00	143.00	108.00	138.00	83.00	109.00	98.00	115.00
73REC	80.00	137.00	149.00	115.00	145.00	90.00	117.00	104.00	126.00
Laminate and Clear Plastic - Square Corners (.125" Thick)									
Part	Black	Brown	Gray	Beige	Clear				
75A	17.00	17.00	17.00	17.00	17.00				
75B	18.30	18.30	18.30	18.30	18.30				
75C	18.30	18.30	18.30	18.30	19.60				
75E	22.10	22.10	22.10	22.10	23.50				
75F	24.80	24.80	24.80	24.80	26.10				
75G	20.80	20.80	20.80	20.80	22.10				
Decorative (.050" Thick)									
Part	3/605 4/606	10/612 10B/613	10BE/BSP	26/625 26D/626					
76B	49.90	56.00	54.00	54.00					
76C	55.00	59.00	59.00	57.00					
77B	49.90	56.00	54.00	54.00					
77C	55.00	59.00	59.00	57.00					

See page 12 for standard locations and sizes of Cylinder Cutouts (CFC) and Thumbturn Cutouts (CFTT), engraving and pricing.

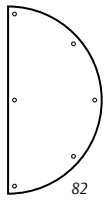

**Push Plates (con't)**

<b>.050" Thick</b>									
Part	28/628	3/605 4/606	10/612 10B/613	10BE/BSP	26/625 26D/626	32D/630	32/629	32DMS	32D316
<b>80</b>	49.30	79.00	88.00	62.00	84.00	46.30	61.00	57.00	78.00
<b>81</b>	52.00	83.00	90.00	67.00	88.00	52.00	68.00	80.00	83.00
<b>82</b>	55.00	89.00	98.00	72.00	95.00	55.00	72.00	68.00	87.00
<b>84</b>	86.00	140.00	151.00	123.00	146.00	94.00	111.00	105.00	128.00
<b>85</b>	32.00	58.00	59.00	43.60	57.00	38.10	38.10	49.00	57.00
<b>86</b>	46.20	69.00	72.00	60.00	69.00	45.20	45.20	56.00	67.00
<b>.125" Thick</b>									
<b>87</b>	81.00	164.00	176.00	144.00	169.00	111.00	132.00	124.00	158.00

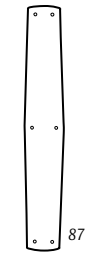

See page 12 for standard locations and sizes of Cylinder Cutouts (CFC) and Thumbturn Cutouts (CFTT), engraving and pricing.

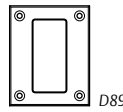

**Flush Pulls**

<b>Heavy Duty Security - Cast Brass</b>												
Part	4/606	26D/626			10BE/BSP							
<b>D89</b>	113.00	74.00			112.00							

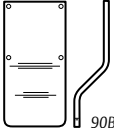

<b>Cylinder Pulls - .125" Thick</b>													
Part	28/628	3/605	4/606	10/612	10B/613	10BE/BSP	26D/626	26/625	32D/630	32/629	32DMS	32D316	32316
<b>90</b>	40.40	44.70	44.70	46.80	46.80	53.00	39.50	49.90	39.20		68.00		
<b>90B</b>	54.00	64.00			67.00	64.00	56.00		51.00		66.00		

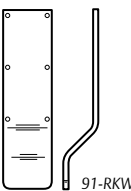

<b>Combination Pulls - .125" Thick - See page 12 for standard locations and sizes of Cylinder Cutouts (CFC) and Thumbturn Cutouts (CFTT), engraving and pricing.</b>													
<b>91-RKW</b>	45.00	75.00	75.00	79.00	79.00	63.00	72.00	78.00	43.00		60.00		
<b>92-RKW</b>	70.00	110.00		114.00	114.00	95.00	111.00		72.00		85.00		
<b>93-RKW</b>	105.00	193.00	193.00	205.00	205.00	175.00	198.00	198.00	131.00	131.00	153.00		

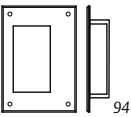

<b>Flush Pulls</b>													
<b>94</b>		62.00	62.00	62.00	62.00	72.00	61.00	62.00	25.40	63.00	54.00	65.00	90.00
<b>94BTB (pair)</b>		127.00	127.00	127.00	127.00	149.00	123.00	127.00	54.00	136.00	117.00	141.00	192.00
<b>94C</b>		68.00	68.00	68.00	68.00	74.00	65.00	68.00	27.50	65.00	56.00	69.00	93.00
<b>94L</b>		100.00			104.00	85.00	100.00		55.00	73.00	64.00	80.00	106.00
<b>94P</b>		88.00			96.00	74.00	93.00		46.80	65.00	56.00	69.00	93.00
<b>94P x 94L</b>		189.00			202.00	161.00	194.00		103.00	140.00	122.00	151.00	210.00

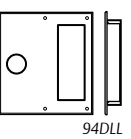

<b>Dead Lock Pulls - For Barrier Free grip specify BF94DLL or BF94DLS. Used with dead bolt lock. 1 1/4" cylinder hole is standard.</b>													
<b>94DLL</b>		152.00			152.00	166.00	144.00		102.00	126.00	126.00	149.00	176.00
<b>94DLS</b>		126.00			126.00	140.00	122.00		80.00	105.00	105.00	125.00	149.00

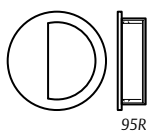

<b>Cast Brass - Fasteners concealed in cup.</b>													
<b>95A</b>		19.20	26.00	20.90	21.30	53.00	20.50	26.00					
<b>95B</b>		21.30	27.50	22.60	22.60	56.00	21.90	27.50					
<b>95R</b>		46.20	46.20	48.30	48.30	74.00	47.30	48.30					

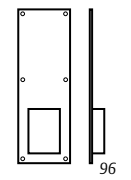

<b>Flush Pull - .125" Thick - See page 12 for standard locations and sizes of Cylinder Cutouts (CFC) and Thumbturn Cutouts (CFTT), engraving and pricing.</b>													
<b>96</b>		123.00			132.00	153.00	128.00		76.00		116.00		

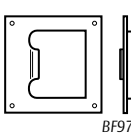

<b>Barrier Free</b>													
<b>BF97</b>		161.00	161.00		170.00	170.00	164.00		85.00		130.00		
<b>BF97L</b>		190.00	190.00		201.00	209.00	194.00		120.00		160.00		

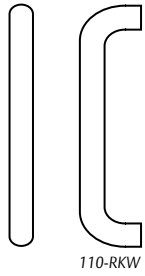

### Straight Door Pulls & Door Pull Sets

Straight Door Pulls & Door Pull Sets													
Part	28/628	313/710 315/711	3/605 4/606	10/612	10B/613	10BE/BSP	26D/626	26/625	32D/630	32/629	32DMS	32D316	32316
102-RKW			59.00	73.00	73.00	34.30	55.00	55.00	33.80	52.00	43.10		
105	19.80	24.80	47.00	55.00	55.00	50.00	47.00	48.10	29.10	38.40	47.80	75.00	91.00
106-RKW	19.80	24.80	47.00	57.00	59.00	53.00	48.10	50.00	29.10	39.50	49.40	77.00	94.00
107	21.50	24.80	55.00	64.00	65.00	76.00	55.00	57.00	30.10	43.10	54.00	79.00	95.00
108	22.60	30.20	61.00	72.00	74.00	69.00	63.00	64.00	35.80	49.40	66.00	90.00	106.00
109	37.60	41.30	91.00	117.00	117.00	169.00	87.00	87.00	58.00	72.00	68.00	89.00	107.00
110-RKW	30.20	36.60	93.00	110.00	112.00	104.00	93.00	96.00	56.00	70.00	102.00	141.00	159.00
111A	39.70	44.00	125.00	174.00	174.00	113.00	122.00	122.00	90.00	104.00	100.00	136.00	152.00
111	31.20	37.60	103.00	123.00	127.00	115.00	101.00	105.00	63.00	76.00	115.00	157.00	174.00
112	32.30	39.70	113.00	138.00	141.00	131.00	112.00	117.00	70.00	83.00	122.00	174.00	195.00
118	57.00	63.00	254.00	254.00	254.00	174.00	196.00	196.00	131.00	155.00	152.00	211.00	200.00

See page 34 for mounting selection and charges. NOTE: For BF Barrier Free projection on applicable straight door pulls add: \$4.80 each list. Add \$57.00 for knurling — round pulls only.

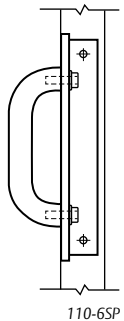

### Security Door Pull

Security Door Pull			
Part	10BE/BSP	32D/630	32DMS
110-6SP	303.00	219.00	275.00

For use on security hollow metal doors with reinforcing plate and access hole cover plate with \*TORX® - security torx screws — all to be supplied by door manufacturer.

### Tubular Door Pulls & Door Pull Sets

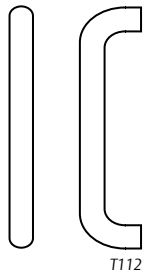

Tubular Straight Door Pulls — Type 1 Thru-Bolt Mount for 1 3/4" Door.						
Part	3/605 4/606	10/612 10B/613	10BE/BSP	32D/630	32/629	32DMS
T110	136.00	139.00	100.00	76.00	93.00	91.00
T111A	143.00	148.00	102.00	78.00	95.00	94.00
T111	143.00	148.00	102.00	78.00	95.00	94.00
T112	150.00	153.00	108.00	81.00	101.00	96.00
T118	168.00	171.00	117.00	93.00	117.00	107.00

\*Torx® is a registered trademark of Textron Inc.



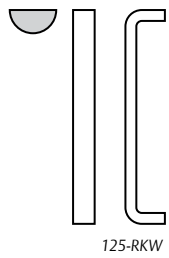

125-RKW

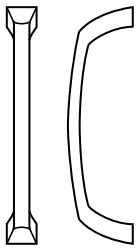

137

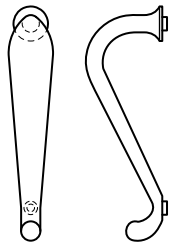

147

**Door Pulls**

Pulls - Engraving available vertically. See page 12 for pricing.										
Part	28/628	3/605 4/606	10/612	10B/613	10BE/BSP	26D/626	26/625	32D/630	32/629	32DMS
<b>120</b>	112.00	238.00	261.00	261.00	172.00	254.00	254.00	137.00	137.00	150.00
<b>121</b>	119.00	254.00	276.00	276.00	184.00	268.00	268.00	142.00	142.00	157.00
<b>122-RKW</b>	32.30	77.00	103.00	103.00	53.00	97.00	97.00	42.10	42.10	56.00
<b>123</b>	38.00	90.00	114.00	114.00	64.00	111.00	111.00	52.00	52.00	64.00
<b>125-RKW</b>	37.60	82.00	87.00	87.00	72.00	84.00	84.00	56.00	56.00	70.00
<b>126-RKW</b>	39.70	96.00	110.00	110.00	81.00	104.00	104.00	63.00	63.00	75.00
Cast Pulls										
<b>130-RKW</b>	22.50	46.00	46.00	48.10	44.70	41.70	50.00	54.00	74.00	75.00
<b>131-RKW</b>	22.50	46.00	46.00	50.00	44.70	43.80	51.00	54.00	74.00	75.00
<b>132-RKW</b>	32.30	50.00		57.00	65.00	54.00		55.00		68.00
<b>D133-RKW</b>		76.00		132.00	81.00	86.00		61.00	66.00	77.00
<b>134-RKW</b>		74.00		79.00	88.00	77.00				
<b>137</b>		60.00		65.00	74.00	63.00		58.00	58.00	71.00
<b>137L</b>		120.00		120.00	135.00	117.00				
<b>138</b>	48.70	84.00		94.00	105.00	91.00				
<b>139</b>	48.70	84.00		94.00	105.00	91.00				
Cast Pulls - See page 34 for mounting selection and charges.										
<b>147</b>	23.70	96.00	96.00	96.00	108.00	94.00	94.00			
<b>147L</b>		163.00	193.00	193.00	217.00	189.00	189.00			
<b>148</b>		144.00	144.00	144.00	163.00	141.00	141.00			
<b>149</b>		178.00	178.00	178.00	200.00	173.00	173.00			

90° Offset Door Pulls & Door Pull Sets

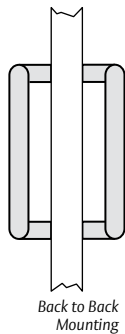
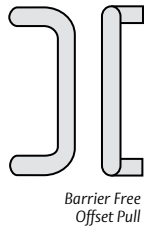

90° Offset Door Pulls & Door Pull Sets												
Part	28/628	313/710 315/711	3/605 4/606	10/612 10B/613	10BE/BSP	26D/626	26/625	32D/630	32/629	32DMS	32D316	32316
BF150	50.00	63.00	124.00	152.00	104.00	120.00	120.00	83.00	107.00	99.00	133.00	150.00
BF151	56.00	67.00	134.00	75.00	112.00	131.00	131.00	89.00	110.00	102.00	140.00	156.00
BF152	56.00	71.00	124.00	152.00	104.00	120.00	120.00	91.00	107.00	104.00	146.00	166.00
BF156	45.00	52.00	132.00	168.00	154.00	134.00	140.00	77.00	96.00	139.00	213.00	236.00
BF157A	45.00	53.00	142.00	182.00	169.00	144.00	149.00	86.00	105.00	152.00	231.00	251.00
BF157	45.00	53.00	142.00	182.00	169.00	144.00	149.00	86.00	105.00	146.00	222.00	241.00
BF158	48.70	55.00	152.00	195.00	181.00	155.00	160.00	92.00	111.00	164.00	248.00	267.00
BF159	71.00	79.00	196.00	230.00	217.00	199.00	205.00	129.00	157.00	200.00	301.00	319.00
Offset Door Pulls - Type 17 Concealed Mount for 1 3/4" Aluminum Door. (Double Cone Head)												
BF156C17	58.00	65.00	145.00	181.00	167.00	147.00	153.00	90.00	109.00	152.00	226.00	249.00
BF157AC17	58.00	66.00	155.00	195.00	182.00	157.00	162.00	99.00	118.00	165.00	244.00	264.00
BF157C17	58.00	66.00	155.00	195.00	182.00	157.00	162.00	99.00	118.00	159.00	235.00	254.00
BF158C17	62.00	68.00	165.00	208.00	194.00	168.00	173.00	105.00	124.00	177.00	261.00	280.00
BF159C17	84.00	92.00	209.00	243.00	230.00	212.00	218.00	142.00	170.00	213.00	314.00	332.00
Tubular Offset Door Pulls - Type 1 Thru-Bolt Mount for 1 3/4" Door.												
TBF156			158.00	161.00	104.00			79.00	114.00	95.00		
TBF157A			163.00	167.00	109.00			81.00	119.00	98.00		
TBF157			163.00	167.00	109.00			81.00	119.00	98.00		
TBF158			168.00	173.00	111.00			85.00	121.00	100.00		
TBF159			209.00	186.00	145.00			87.00	126.00	127.00		
Tubular Offset Door Pull - Type 17 Concealed Mount for 1 3/4" Aluminum Door. (Double Cone Head)												
TBF156C17			171.00	174.00	117.00			92.00	127.00	108.00		
TBF157AC17			176.00	180.00	122.00			94.00	132.00	111.00		
TBF157C17			176.00	180.00	122.00			94.00	132.00	111.00		
TBF158C17			181.00	186.00	124.00			98.00	134.00	113.00		
TBF159C17			222.00	256.00	243.00			155.00	183.00	226.00		

See page 34 for mounting selection and charges. Back to Back Mounting Available: Specify by adding "BTB" to end of part number. For pricing, double the pull price and add \$12.62.

**45° Offset Door Pulls**

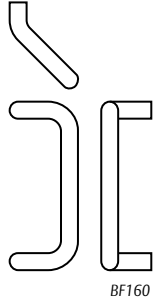

Part	28/628	313/710 315/711	3/605 4/606	10/612 10B/613	10BE/BSP	26/625 26D/626	32D/630	32/629	32DMS	32D316	32316
<b>BF160</b>	50.00	63.00	124.00	152.00	104.00	120.00	83.00	107.00	99.00	133.00	150.00
<b>BF161</b>	56.00	67.00	134.00	165.00	112.00	131.00	89.00	110.00	102.00	140.00	156.00
<b>BF162</b>	50.00	67.00	141.00	165.00	119.00	120.00	91.00	107.00	104.00	133.00	166.00
<b>BF166</b>	60.00	71.00	173.00	209.00	183.00	168.00	146.00	159.00	161.00	197.00	224.00
<b>BF167A</b>	67.00	78.00	182.00	219.00	190.00	177.00	152.00	165.00	166.00	204.00	224.00
<b>BF167</b>	67.00	78.00	182.00	219.00	197.00	177.00	156.00	168.00	171.00	215.00	232.00
<b>BF168</b>	75.00	85.00	193.00	230.00	209.00	189.00	159.00	182.00	183.00	230.00	248.00
<b>BF169</b>	93.00	108.00	235.00	268.00	252.00	228.00	193.00	214.00	221.00	278.00	295.00

See page 34 for mounting selection and charges.

**Offset Door Pulls**

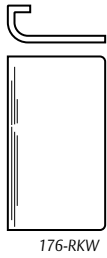

Part	28/628	313/710 315/711	3/605 4/606	10/612 10B/613	10BE/BSP	32D/630	32DMS
<b>176-RKW</b>	162.00	174.00	464.00	520.00	299.00	237.00	249.00
<b>177</b>	180.00	190.00	520.00	573.00	358.00	284.00	295.00
<b>185</b>	195.00	225.00	727.00	727.00	656.00	520.00	527.00

Call factory for engraving and pricing.

**Wooden Door Pull**

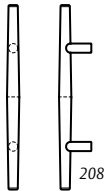

Part	28/628	313/710 315/711	3/605 4/606	10/612 10B/613	10BE/BSP	26/625 26D/626	32D/630	32/629	32DMS
<b>208</b>	274.00	274.00	263.00	263.00	300.00	254.00	247.00	254.00	261.00

Wood available in Sanded - Unfinished, Oil, or Clear Coated. See page 34 for mounting details. Please see Architectural Price Book page 39 for add on charges.

**Tapered Door Pull**

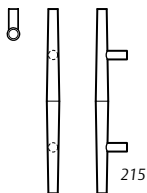

Part	28/628	313/710 315/711	3/605 4/606	10/612 10B/613	10BE/BSP	26/625 26D/626	32D/630	32/629	32DMS
<b>215</b>	290.00	307.00	490.00	548.00	428.00	532.00	324.00	378.00	352.00
<b>215L</b>	386.00	407.00	883.00	966.00	729.00	935.00	553.00	655.00	587.00

Larger sizes available upon request. See page 34 for mounting details.

**Hands Free Pulls**

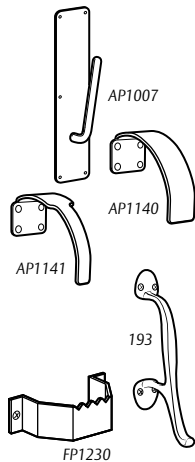

Arm Pull with Plate						
Part	3/605 4/606	10/612 10B/613	10BE/BSP	26/625 26D/626	32D/630	32DMS
<b>AP1007</b>			197.00		187.00	206.00
Arm Pulls						
<b>AP1140</b>			67.00			70.00
<b>AP1141</b>			66.00			69.00
Hand/Arm Pull						
<b>193</b>	73.00	77.00	86.00	74.00	67.00	76.00
Foot Pull						
<b>FP1230</b>			68.00		64.00	71.00

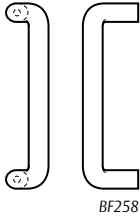

Heavy Duty Offset Pulls

Heavy Duty Offset Pulls											
Part	28/628	313/710 315/711	3/605 4/606	10/612 10B/613	10BE/BSP	26/625 26D/626	32D/630	32/629	32DMS	32D316	32316
BF257	175.00	190.00	434.00	499.00	354.00	423.00	281.00	344.00	302.00	378.00	420.00
BF258	190.00	208.00	468.00	530.00	384.00	453.00	305.00	369.00	328.00	402.00	484.00
BF259	196.00	216.00	530.00	610.00	424.00	514.00	336.00	400.00	358.00	438.00	484.00
BF260	196.00	208.00	434.00	610.00	465.00	453.00	294.00	344.00	336.00	402.00	448.00

Supplied with 3/8" -16 Thru Bolts.

Vandal Resistant Trim

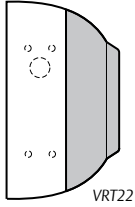

Vandal Resistant Trim			
Part	10BE/BSP	32D/630	32DMS
VRT12	346.00	282.00	321.00
VRT14	348.00	228.00	323.00
VRT16	299.00	202.00	277.00
VRT22		343.00	
VRT24		289.00	
VRT26		259.00	

Specify Exit Device make and model to thru bolt directly to device.

Order form available when ordering.

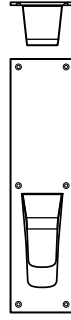

Vandal Resistant Pull

Vandal Resistant Pull		
Part	10BE/BSP	32D/630
VRP30	162.00	149.00

Set up charge for custom powder will apply. Specify Exit Device make and model to thru bolt directly to device (add on price will occur.)

Order form available when ordering.

Pull Plates

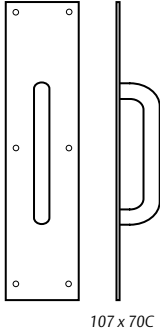

Pull Plates												
Part	28/628	3/605	4/606	10/612	10B/613	10BE/BSP	26D/626	26/625	32D/630	32/629	32DMS	32D316
102 x 70B		61.00	61.00	64.00	64.00	62.00	60.00	63.00	34.90	47.90	51.00	
102 x 70C		67.00	67.00	70.00	70.00	66.00	65.00	67.00	34.90	51.00	51.00	
105 x 70B	33.00	74.00	74.00	82.00	82.00	78.00	74.00	76.00	43.60	56.00	75.00	108.00
105 x 70C	34.60	77.00	77.00	87.00	87.00	82.00	79.00	81.00	43.60	58.00	78.00	111.00
106 x 70B	33.00	75.00	75.00	84.00	86.00	82.00	75.00	77.00	43.60	57.00	76.00	110.00
106 x 70C	34.60	79.00	79.00	88.00	90.00	86.00	81.00	82.00	43.60	60.00	79.00	113.00
107 x 70B	33.00	81.00	81.00	90.00	92.00	87.00	81.00	83.00	44.70	61.00	79.00	111.00
107 x 70C	34.60	84.00	84.00	97.00	97.00	91.00	86.00	88.00	39.80	64.00	81.00	114.00
110 x 70B	42.50	117.00	117.00	136.00	138.00	131.00	117.00	121.00	71.00	89.00	131.00	178.00
110 x 70C	42.50	122.00	122.00	139.00	142.00	135.00	122.00	125.00	73.00	92.00	133.00	181.00
111 x 70B	43.50	127.00	127.00	148.00	151.00	144.00	126.00	129.00	78.00	97.00	143.00	195.00
111 x 70C	45.10	130.00	130.00	152.00	157.00	148.00	129.00	135.00	79.00	99.00	145.00	195.00
122 x 70B	34.60	71.00	71.00	77.00	79.00	74.00	75.00	77.00	54.00	65.00	71.00	83.00
122 x 70C	35.70	76.00	76.00	82.00	83.00	79.00	79.00	82.00	55.00	56.00	71.00	84.00
123 x 70B	37.20	88.00	88.00	89.00	89.00	85.00	89.00	92.00	58.00	61.00	76.00	90.00
123 x 70C	38.30	95.00	95.00	95.00	95.00	88.00	94.00	97.00	60.00	61.00	76.00	91.00
125 x 70B	37.20	79.00	79.00	82.00	82.00	78.00	77.00	83.00	62.00	110.00	125.00	148.00
125 x 70C	38.30	84.00	84.00	86.00	86.00	82.00	82.00	88.00	64.00	65.00	80.00	95.00
126 x 70B	37.20	86.00	86.00	88.00	88.00	83.00	84.00	89.00	73.00	74.00	88.00	104.00
126 x 70C	38.30	90.00	90.00	92.00	92.00	87.00	88.00	94.00	73.00	75.00	89.00	107.00
132 x 70B	31.00	58.00	59.00	60.00	61.00	58.00	58.00	67.00	52.00	54.00	69.00	
132 x 70C	32.00	61.00	63.00	64.00	65.00	62.00	61.00	73.00	52.00	54.00	69.00	
137 x 70B	35.70	68.00	70.00	70.00	71.00	67.00	68.00	71.00	64.00	65.00	80.00	
137 x 70C	38.30	73.00	75.00	74.00	75.00	72.00	74.00	75.00	64.00	67.00	81.00	

Barrier Free - Available in 2 1/2" clearance add \$4.80 list (excludes 132 and 137).

**Decorative Pull Plates**

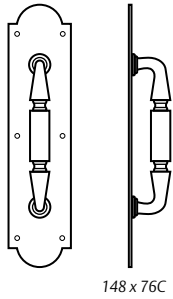

148 x 76C

Decorative Pull Plates				
Part	3/605 4/606	10/612 10B/613	10BE/BSP	26/625 26D/626
<b>147 x 76B</b>	157.00	165.00	190.00	158.00
<b>147 x 76C</b>	164.00	168.00	194.00	232.00
<b>147 x 77B</b>	157.00	165.00	190.00	158.00
<b>147 x 77C</b>	164.00	168.00	194.00	232.00
<b>148 x 76B</b>	206.00	212.00	244.00	206.00
<b>148 x 76C</b>	212.00	219.00	252.00	210.00
<b>148 x 77B</b>	206.00	212.00	244.00	206.00
<b>148 x 77C</b>	212.00	219.00	252.00	210.00

**Tubular Pull Plates**

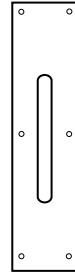

T110 x 70C

Tubular Pull Plates						
Part	3/605 4/606	10/612 10B/613	10BE/ BSP	32D/630	32/629	32DMS
<b>T110 x 70B</b>	164.00	178.00	123.00	98.00	125.00	114.00
<b>T110 x 70C</b>	172.00	182.00	125.00	101.00	128.00	116.00
<b>T111 x 70B</b>	176.00	185.00	125.00	101.00	130.00	116.00
<b>T111 x 70C</b>	179.00	189.00	132.00	106.00	133.00	122.00

**Corner Guards**



290

Corner Guards				
Part	Size	3/605 4/606	10/612 10B/613	32D/630
<b>290</b>	2" x 2" x 40"	100.00	120.00	67.00
	2" x 2" x 48"	106.00	127.00	71.00
	3" x 3" x 40"	114.00	137.00	76.00
	3" x 3" x 48"	124.00	148.00	83.00
<b>291</b>	2" x 2" x 40"	108.00	130.00	73.00
	2" x 2" x 48"	114.00	137.00	76.00
	3" x 3" x 40"	122.00	147.00	82.00
	3" x 3" x 48"	132.00	158.00	89.00

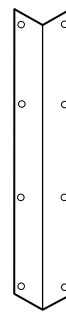

295

Corner Guards						
Part	Size	3/605 4/606	10/612 10B/613	10BE/ BSP	32D/630	32DMS
<b>295</b>	2" x 2" x 40"	80.00	96.00	78.00	54.00	75.00
	2" x 2" x 48"	86.00	103.00	84.00	58.00	82.00
	3" x 3" x 40"	94.00	114.00	93.00	63.00	90.00
	3" x 3" x 48"	103.00	125.00	101.00	70.00	98.00
	2" x 2" x 40"	92.00	110.00	90.00	62.00	88.00
<b>296</b>	2" x 2" x 48"	98.00	118.00	96.00	66.00	94.00
	3" x 3" x 40"	107.00	128.00	104.00	71.00	101.00
	3" x 3" x 48"	116.00	139.00	114.00	77.00	110.00

Other lengths available up to 96" and leg widths up to 6". Part number 290 and 291 includes self-adhesive mounting.

**Mortised Door Edges (UL Approved)**

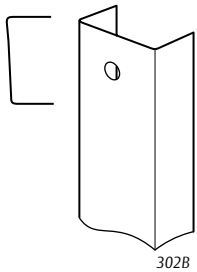

302B

Mortised Door Edges							
Part	Height	3/605 4/606	10/612 10B/613	10BE/BSP	32D/630	32DMS	32D316
<b>300</b>	Up to 42"	117.00	126.00	83.00	66.00	79.00	97.00
	43" - 66"	178.00	193.00	124.00	97.00	117.00	151.00
	67" - 96"	263.00	279.00	171.00	138.00	162.00	212.00
<b>301</b>	Up to 42"	117.00	126.00	83.00	66.00	79.00	97.00
	43" - 66"	178.00	193.00	124.00	97.00	117.00	151.00
	67" - 96"	263.00	279.00	171.00	138.00	162.00	212.00
<b>302</b>	Up to 42"	132.00	140.00	96.00	66.00	91.00	108.00
	43" - 66"	193.00	211.00	142.00	97.00	134.00	168.00
	67" - 96"	288.00	304.00	197.00	138.00	186.00	246.00
<b>302B</b>	Up to 42"	132.00	140.00	96.00	76.00	91.00	108.00
	43" - 66"	193.00	211.00	142.00	115.00	134.00	168.00
	67" - 96"	288.00	304.00	197.00	162.00	186.00	246.00

Available in stainless steel, brass and bronze. UL Listed for fire rated doors. Add \$14.10 per edge - specify UL when ordering (300-UL). Includes Phillips Flat Head Sheet Metal Screw Fasteners. To defray set up costs, add 30% for less than 10 pieces. Add an additional \$13.00 for each cutout.

Order form available when ordering.

Non-Mortise Door Edges (UL Approved)

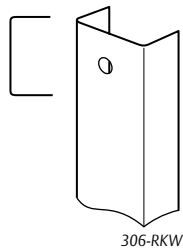

306-RKW

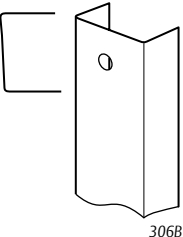

306B

Non-Mortise Door Edges							
Part	Height	3/605 4/606	10/612 10B/613	10BE/BSP	32D/630	32DMS	32D316
304	Up to 42"	117.00	126.00	83.00	66.00	79.00	97.00
	43" - 66"	178.00	193.00	124.00	97.00	117.00	151.00
	67" - 96"	263.00	279.00	171.00	138.00	162.00	217.00
305	Up to 42"	117.00	126.00	83.00	66.00	79.00	97.00
	43" - 66"	178.00	193.00	124.00	97.00	117.00	151.00
	67" - 96"	263.00	279.00	171.00	138.00	162.00	217.00
306-RKW	Up to 42"	132.00	140.00	96.00	76.00	91.00	108.00
	43" - 66"	193.00	211.00	142.00	115.00	134.00	168.00
	67" - 96"	288.00	304.00	197.00	162.00	186.00	246.00
306-AST	Up to 96"	754.00	754.00	752.00	712.00	712.00	798.00
306B	Up to 42"	132.00	140.00	96.00	76.00	91.00	108.00
	43" - 66"	193.00	211.00	142.00	115.00	134.00	168.00
	67" - 96"	288.00	304.00	197.00	162.00	186.00	246.00
306B-AST	Up to 96"	754.00	754.00	752.00	712.00	712.00	798.00
307	Up to 42"	151.00	160.00	116.00	95.00	109.00	131.00
	43" - 66"	229.00	245.00	176.00	145.00	165.00	200.00
	67" - 96"	338.00	352.00	258.00	208.00	244.00	300.00

Available in stainless steel, brass and bronze. UL Listed for fire rated doors. Add \$14.10 per edge - specify UL when ordering (304-UL). Includes Phillips Flat Head Sheet Metal Screw Fasteners. To defray set up costs, add 30% for less than 10 pieces. Add an additional \$13.00 for each cutout.

Order form available when ordering.

Overlapping Door Edges (UL Approved)

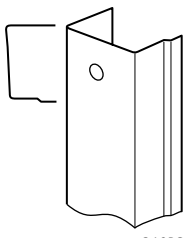

310BS

Overlapping Door Edges							
Part	Height	3/605 4/606	10/612 10B/613	10BE/BSP	32D/630	32DMS	32D316
308	Up to 42"	132.00	140.00	96.00	76.00	91.00	108.00
309	Up to 42"	132.00	140.00	96.00	76.00	91.00	108.00
310	Up to 42"	148.00	157.00	96.00	76.00	91.00	108.00
310B	Up to 42"	148.00	157.00	96.00	76.00	91.00	108.00
310BS	Up to 42"	148.00	157.00	96.00	76.00	91.00	108.00

Available in stainless steel, brass and bronze. UL Listed for fire rated doors. Add \$14.10 per edge - specify UL when ordering (308-UL). Includes Phillips Flat Head Sheet Metal Screw Fasteners. To defray set up costs, add 30% for less than 10 pieces. Add an additional \$13.00 for each cutout.

Order form available when ordering.

Latch Protectors

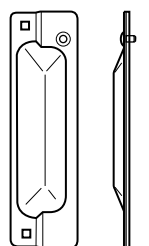

320-RKW

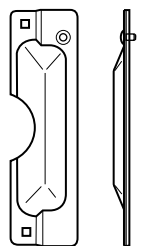

320CL

Latch Protectors				
Part	2C/603	10BE/BSP	26D/626	32D/630
320-RKW	15.70	51.00		29.10
320C	15.70	51.00		29.10
320CL	15.70	51.00		29.10
320CXL		51.00		29.10
321	12.10	37.70		21.50
322	11.00	37.70		17.50
325		87.00	50.00	
330		92.00		52.00

Stops

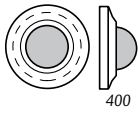

Solid Cast Wall Stops - Rubber Bumper							
Part	3/605	4/606 10/612 10B/613	10BE/BSP	15/619	26D/626	26/625	
400	9.40	12.00	15.90	12.00	8.00	15.00	
401	9.60	12.30	15.00	12.30	8.30	15.20	
402	10.00	12.70	15.60	12.70	8.80	15.80	
403	9.40	12.00	15.90	12.00	8.00	15.00	
404	9.60	12.30	16.30	12.30	8.30	15.20	
405	10.00	12.70	16.90	12.70	8.80	15.80	

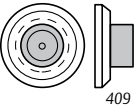

Wrought Wall Stops - Rubber Bumper							
Part	3/605 4/606	10/612	10BE/BSP	26D/626	26/625	32D/630	
406	4.00	4.00	5.50	4.00	4.20	2.60	
409	4.00	4.00	5.50	4.00	4.20	2.60	

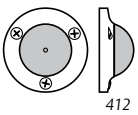

Solid Cast Wall Stops - Rubber Bumper							
Part	3/605	4/606 10/612 10B/613	10BE/BSP	15/619	26D/626	26/625	
412	13.80	14.80	40.50	14.80	12.70	14.30	
415	33.20	32.20	49.90	23.90	21.80	33.20	
416	13.80	14.80	40.50	14.90	12.70	14.30	

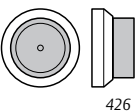

Wrought Wall Stops - Rubber Bumper							
Part	3/605	10BE/BSP	32D/630				
426	4.60	12.40	4.50				

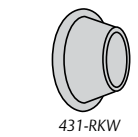

Solid Cast Wall Stop - Rubber Bumper							
Part	3/605 26/625	4/606	10B/613	10BE/BSP	15/619	26D/626	
430-RKW	7.70	8.60	8.30	11.40	12.30	6.40	



Wall Stops - Rubber Bumper			
Part	Gray	White	
431-RKW	2.60		
432W		2.40	



Dome Stops								
Part	3/605	4/606	10/612	10B/613	10BE/BSP	15/619	26D/626	26/625
440	6.10	6.50	7.50	6.80	10.30	9.40	5.60	6.40
441	7.00	6.80	7.80	7.20	11.30	8.60	6.40	6.80
441CU	10.50	10.00	11.70	10.50	15.90	9.90	9.30	9.90
441H	10.80	10.80	11.70	11.70	16.70	12.60	8.70	11.10
442	7.30	7.30	7.70	8.30	12.20	10.40	7.20	7.40
443	7.80	7.70	8.90	8.30	11.80	9.50	6.80	8.00



Cast Riser (for 440 & 441 Dome Stops)								
Part	3.50	3.50	3.80	3.80	5.50		3.20	3.50
444								

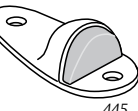

Heavy Duty Door Stops									
Part	3/605	4/606	10/612	10B/613	26D/626	10BE/BSP	15/619	26/625	32D/630
445	23.00	22.50	22.50	22.50	14.80	32.70	24.10	23.20	
445H	34.30	34.30	34.30	38.40	22.90	52.00	38.40	34.30	

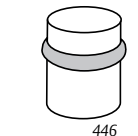

Door Stop									
Part	27.00	27.00	28.00	28.00	20.00	41.00	29.00	27.00	32.00
446									

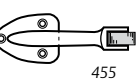

Curved Roller Stop - Rubber Bumper						
Part	3/605	4/606 10/612	10B/613	10BE/BSP	15/619 26/625	26D/626
455	30.10	33.20	34.80	46.10	36.40	28.60

Straight Roller Stops - Rubber Bumper								
Part	3/605	4/606	10/612	10B/613	10BE/BSP	15/619	26D/626	26/625
456-RKW	31.20	33.20	31.70	33.20	49.40	36.40	25.80	31.20
456B Gray (replacement bumper)								5.50
456L	34.30	35.30	35.30	36.40	51.00	45.20	32.20	42.10

Kick Down Door Stop - Rubber Bumper	
Part	BRS, BRZ, CRM
458	8.60

Spring Loaded Plunger Stop - Rubber Bumper								
Part	3/605	4/606	10/612	10B/613	10BE/BSP	15/619	26D/626	26/625
459	36.40	36.40	36.40	39.50	55.00	40.00	29.10	39.00

Kick Down Door Stops - Rubber Bumper								
Part	ALM, BRS, BRZ, ORB							
460								13.90
461	27.50	30.60	30.60	28.10	47.20	36.40	25.20	40.00
461B Gray or Black (replacement bumper)								3.60

Heavy Duty Door Stops								
Part	3/605	4/606	10/612	10B/613	10BE/BSP	15/619	26D/626	26/625
461L	40.00	38.40	38.40	39.00	54.00	41.60	30.10	42.60

Heavy Duty Door Stops				
Part	2C/603	26D/626	32D/630	Black (BLK)
462	36.40			
463-RKW			37.40	
464-RKW		77.00		
465		49.90		
466-RKW				23.50
467-RKW				34.30
468-RKW				87.00

Door Stops - Rubber Bumper								
Part	3/605	4/606	10/612	10B/613	10BE/BSP	15/619	26D/626	26/625
470	23.90	29.10	29.10	31.20	41.10	34.30	23.20	33.80
471	23.90	29.10	29.10	31.20	41.10	34.30	23.20	33.80
472	49.40	49.40	49.40	53.00	70.00	56.00	31.70	58.00
473	49.40	49.40	49.40	53.00	70.00	56.00	31.70	58.00
474	30.10	30.60	30.60	31.20	41.10	34.30	22.60	33.80
475	28.60	29.10	29.10	31.20	41.10	32.70	22.80	32.20
476	43.10	43.10	43.10	46.20	62.00	49.40	30.60	54.00
477	43.10	43.10	43.10	46.20	62.00	49.40	30.60	54.00
480	27.00	25.80	25.80	27.00	36.10	34.30	22.90	33.20
480H	31.70	30.10	30.10	31.20	41.10	37.40	25.70	37.40
481	30.60	30.60	30.60	32.20	43.30	35.30	23.80	33.80
481H	32.20	31.20	31.20	32.70	43.30	38.40	26.50	38.40
481MP Powder Coat Finish								87.00
482	22.90	26.50	26.50	24.20	35.50	30.10	21.50	30.10
483	25.20	27.00	27.00	25.80	35.50	33.20	23.20	31.70
485	40.50	36.40	36.40	39.00	52.00	41.60	31.20	41.60

Angle Door Stop - Rubber Bumper	
Part	2C/603
486	9.60

Heavy Duty Wall Stop - Rubber Bumper	
Part	26D/626
487	39.00



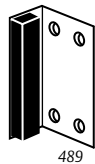

Door Stops (con't)

Door Stops						
Part	3/605	4/606	10/612	10B/613	10BE/BSP	15/619
488	55.00	55.00	60.00	60.00	92.00	58.00
489	67.00	67.00	74.00	74.00	109.00	74.00

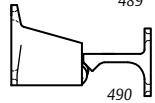

Door Holder & Stop	
Part	26D/626
490	37.40

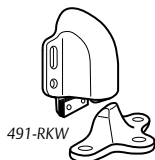

Automatic Door Holder & Stop								
Part	3/605	4/606	10/612	10B/613	10BE/BSP	15/619	26D/626	26/625
491-RKW	55.00	58.00	58.00	62.00	81.00	73.00	54.00	75.00
491R	57.00	60.00	60.00	63.00	83.00	144.00	55.00	76.00
491S	58.00	61.00	61.00	64.00	85.00		56.00	78.00
494-RKW	68.00	70.00	68.00	70.00	94.00	83.00	63.00	85.00
494R	69.00	72.00	69.00	72.00	95.00		64.00	86.00
494S	70.00	73.00	70.00	73.00	97.00		65.00	87.00

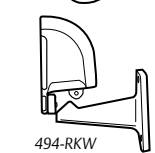

Concealed Magnetic Door Stop			
Part	26D/626	Black (BLK)	Clear
495*	29.00	25.00	25.00

\*Coming Soon - November 2021

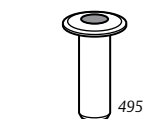

Door Stops - Rubber Bumper								
Part	3/605	4/606	10/612	10B/613	10BE/BSP	15/619	26D/626	26/625
505-RKW	11.80	15.50	15.50	15.50	20.60	16.70	11.50	14.20
508	18.90	18.90	18.90	20.80	27.60	21.30	17.50	18.90



Part	Polished Brass (BRS)				Burnished Aluminum (ALM)			
517	4.70				4.50			
518	15.10	15.50	15.50	17.20	22.70	17.20	12.90	15.20
519	12.70	15.10	15.10	16.20	21.50	17.00	12.00	15.10

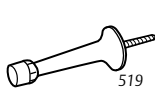

520	White (replacement bumper) 7.00							
-----	---------------------------------	--	--	--	--	--	--	--

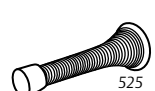

Part	Antique Brass (ANT)	Polished Brass (BRS)	Bright Nickel (NP)	Black (BLK)
525	1.40	1.40	1.60	1.60
526		1.50	1.80	
528	4.30	4.30	5.00	

Flush Bolts, Guides & Strikes

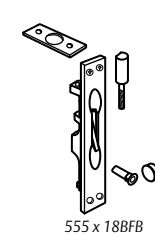

Flush Bolts, Guides & Strikes								
Part	3/605	4/606	10/612	10B/613	10BE/BSP	15/619	26D/626	26/625
550	25.60	31.20	31.20	33.20	47.20	35.30	25.80	40.00
550G	7.20			7.20	9.50		5.90	
550S	7.20			7.20	9.50		5.90	
554	58.00			58.00	82.00		56.00	
554G	39.00			39.00	55.00		37.40	
554S	39.00			39.00	55.00		37.40	
555	19.00	19.00	20.70	19.80	32.20	24.20	15.30	20.90
555B (1 1/2" standard bolt head)				7.20				
555B (extra long bolt head - specify length)				22.60				
555G	6.00			6.00	7.90		4.80	
555S	6.00			6.00	7.90		4.80	
555ROD/per ft. (specify length)								3.10
555 x 18BFB							154.00	
556WS							43.60	
557	29.10	29.10	29.10	29.10	51.00	39.00	29.10	30.10
557S	7.20			7.20	7.30		5.90	
557 x 19BFB							171.00	
570	21.80	20.30	22.70	22.70	36.60	26.50	17.20	21.90

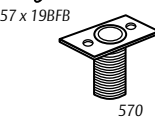
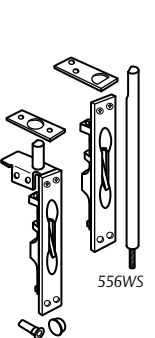

Gravity Door Coordinator

Gravity Door Coordinators					
Part	3/605 4/606	10/612 10B/613	10BE/BSP	15/619 26/625	26D/626
576	69.00	69.00	105.00	77.00	59.00
576B Gray	2.80				

Surface Bolts

Surface Bolts					
Part	3/605	10B/613	10BE/BSP	26D/626	32D/630
580-8	32.20	33.80	73.00	27.00	57.00
580-12			85.00	31.70	
580-18			212.00	140.00	
580-24			228.00	156.00	
582-8					117.00
582-12					143.00

Heavy Duty Surface Bolts

585-12				122.00	
585-24				151.00	

Roller Latches

Roller Latches										
Part	3/605	4/606	10/612	10B/613	10BE/BSP	15/619	26D/626	26/625		
590	32.70	45.70	45.70	35.30	61.00	39.00	27.00	33.80		
Part			3/605	10B/613	26D/626					
590DA (Strike Only)	106.00			106.00	106.00					
590SO	19.40	19.40	19.40	19.40	27.20	23.20	18.10	18.10		
591	35.30	48.30	48.30	42.10	64.00	54.00	29.60	45.70		
591SO	23.20	23.20	21.90	23.20	30.70	27.00	20.60	20.60		
592	32.70	45.70	45.70	34.30	61.00	45.70	27.00	33.80		
592SO	19.40	19.40	19.40	19.40	27.20	21.90	18.10	18.10		
Part			3/605	10B/613	26D/626	26/625				
593	68.00	68.00	90.00	77.00	50.00	74.00				
Part			3/605	4/606	10/612	10B/613	10BE/BSP	15/619	26D/626	26/625
593SO	19.40			19.40	27.20			18.10		
594	42.10	42.10	42.10	46.20	61.00	46.20	28.60	42.10		
594SO					27.20					

Gate Latch

Gate Latch				
Part	4/606	10/612 10B/613	10BE/BSP	26D/626
602	49.90	49.90	69.00	46.80
602 Spring (25 pk)				15.20



Door Guards

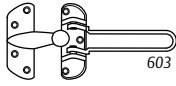

Door Guards					
Part	Antique Brass (ANT)	Polished Brass (BRS)	Bright Chrome (CRM)		
603	12.60	12.60	12.60		
603 Shim	Clear Plastic		3.40		
Part	3/605	4/606	10/612 10B/613 15/619	26D/626	26/625
604	28.10	26.50	29.10	22.60	26.50
604 Shim	Clear Plastic		3.50		

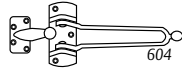

Door Guard Protection Plate

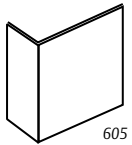

Door Guard Protection Plate				
Part	3/605 4/606	10/612 10B/613 15/619	26D/626	26/625
605	6.40	6.40	6.90	7.20
605SMS	13.20	14.50	13.20	13.20

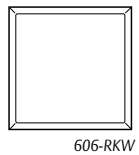

Wall Guard

Wall Guard		
Part	Pack Size	Clear
606-RKW	55/sheet	57.00

Privacy Door Latch

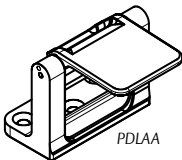

Privacy Door Latch						
Part	3/605	4/606	10BE/BSP	15/619	26/625	26D/626
PDLAA	36.50	36.50	36.50	32.10	34.00	32.10

Door Silencers

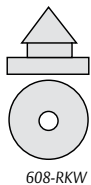

Door Silencers			
Part	Pack Size	Clear	Gray Rubber
608-RKW	100		9.90
608CA	300	101.00	
609	100		14.60

Door Knockers

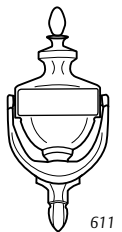

Door Knockers							
Part	3/605	4/606	10/612	10B/613	10BE/BSP	15/619	26D/626
611	42.60	55.00	55.00	58.00	75.00	61.00	41.60
614	34.80	45.70	37.40	45.70	62.00	58.00	33.80
614V	44.90	55.80	68.10	55.80	70.10	55.80	43.90

For 611, drill for Viewer. Add \$5.00.

Door Viewers

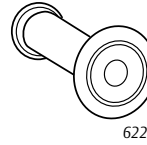

Door Viewers					
Part	Antique Bronze (ANT)	Polished Brass (BRS)	Bright Chrome (CRM)	Satin Nickel (STNN)	Dull Chrome (DCRM)
619	11.80	10.80	10.80	11.50	
620	6.70	6.70	6.70	7.80	
621	7.90	7.90	7.90		
622	10.10	10.10	10.10	11.50	10.20

Door Viewer Washers

Door Viewer Washers				
Part	Antique Bronze (ANT)	Polished Brass (BRS)	Bright Chrome (CRM)	Satin Nickel (STNN)
618W	8.60	8.60	8.60	8.50

\* Universal washer to fit all Rockwood Door Viewers.

Door Viewers with Covers

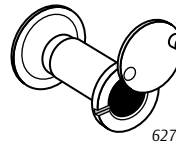

Door Viewers with Covers						
Part	Pack Size	Antique Bronze (ANT)	Polished Brass (BRS)	Bright Chrome (CRM)	Dull Chrome (DCRM)	Black (BLK)
620VC Covers Only	10	46.80	46.80	46.80		
622VC Covers Only	10	58.00	58.00	58.00		
624		10.60	10.60	10.60		
626		13.80	13.80	13.80	13.80	
627				19.50		25.70
628				19.00		24.90
629				20.50		27.00

Surface Bolts

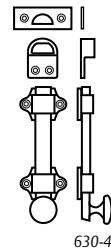

Surface Bolts				
Part	3/605	10B/613	10BE/BSP	26D/626
630-4	28.10	33.20	70.00	27.00
630-8	52.00	62.00	110.00	50.00
630-12	94.00	121.00	187.00	117.00
630-24	158.00	204.00	353.00	197.00

Card Holder



Card Holder				
Part	3/605 4/606	10/612 10B/613	10BE/BSP	26D/626
651	22.50	22.50	29.40	21.20

Decals

Decals	
Part	Price
660	7.20
661	7.20
662-RKW	7.40

THIS DOOR TO REMAIN UNLOCKED DURING BUSINESS HOURS

660

THIS DOOR TO REMAIN UNLOCKED WHILE BUILDING IS OCCUPIED

661

THESE DOORS TO REMAIN UNLOCKED WHILE BUILDING IS OCCUPIED

662-RKW

**ASSA ABLOY**

Opening Solutions

Experience a safer  
and more open world

670 Series Engraved Signs

•SPECIFY COPY•

670

•WOMEN•

670W

P  
U  
S  
H

674H

670 Series Engraved								
Part	Black or Brown Plastic	28/628	3/605 4/606	10/612	10B/613	10BE/BSP	26/625 26D/626	32D/630
670 (1"H Letters or smaller)	8.60	11.80	12.10	12.50	12.80	27.60	12.50	23.10
670M	21.60	38.90	35.30	39.50	39.50	61.00		44.10
670W	30.70	54.00	56.00	62.00	62.00	85.00		63.00
670R	21.60	79.00	81.00	81.00	81.00	115.00		93.00
674H (PUSH)	25.30	33.00	49.40	44.20	44.20	59.00	44.20	47.90
674L (PULL)	25.30	33.00	49.40	44.20	44.20	59.00	44.20	47.90

Available in .125" thick plastic or .050" thick metal. Pricing for 670 is minimum of 3 letters. Over 3 letters there will be an additional charge per letter; per sign for Part's 670M, 670W, 670R. Over 1"H letters contact factory for pricing. Call for pricing on multi-line signs.

BF680 Series Barrier Free Signs

•SPECIFY COPY•

BF680

BF680 Series Barrier Free									
Part	Black, Blue, Brown or Red Plastic	28/628	3/605 4/606	10/612	10B/613	10BL/614	10BE/BSP	26/625 26D/626	32D/630
BF680	20.70	38.40	37.40	37.40	37.40	41.00	44.90	35.90	45.70
BF680M	38.70	87.00	81.00	81.00	81.00	95.00	119.00	77.00	94.00
BF680W	56.00	126.00	118.00	118.00	118.00	132.00	183.00	113.00	146.00
BF680R	79.00	184.00	171.00	171.00	171.00	187.00	281.00	166.00	227.00

Standard 1" letter height. Grade 2 Braille translations. Available in .125" non-glare plastic or .050" thick metal. Pricing is per letter for Part BF680 priced 3 letter minimum. Over 3 letters there will be additional charger per letter for Part's BF680M, BF680W, BF680R. Screw mounting provided. Self-adhesive mounting available.

BF Series ADA Tactile Signs



BF685



BF687



BF688

BF Series ADA Tactile						
Part	Black, Blue, Brown or Red Plastic	3/605 4/606	10/612 10BL/614	10BE/BSP	26/625 26D/626	32D/630
BF683	67.00	199.00	199.00	227.00	183.00	184.00
BF684	67.00	197.00	197.00	227.00	183.00	184.00
BF685	67.00	197.00	197.00	227.00	183.00	184.00
BF686	67.00	229.00	229.00	266.00	212.00	214.00
BF687	67.00	213.00	213.00	247.00	196.00	198.00
BF688	67.00	213.00	213.00	247.00	196.00	198.00
BF689	67.00	229.00	229.00	266.00	212.00	214.00

Standard 1" letter height. Grade 2 Braille translations. Available in .125" non-glare plastic or .050" thick metal. Screw mounting provided. Self-adhesive mounting available.

BFM Series ADA Molded Plastic Signs



BFM687



BFM688



BFM689

Molded Plastic		
Part	Black	Blue
BFM682	17.90	17.90
BFM684	17.90	17.90
BFM685	17.90	17.90
BFM686	17.90	17.90
BFM687	17.90	17.90
BFM688	17.90	17.90
BFM689	17.90	17.90

Standard 5/8" letter height. Grade 2 Braille translations. Self-adhesive mounting.



BFM624



BFM625

All Gender Restroom Signs

Molded Plastic	
Part	Blue
BFM624	24.50
BFM625*	19.50

\*Standard 5/8" letter height. Grade 2 Braille translations. Self-adhesive mounting.

Auxiliary Hardware

Hand Rail Brackets - Specify Wood or Metal Rail

Part	3/605	10B/613	10BE/BSP	15/619	26D/626	26/625
700	63.00	70.00		77.00	68.00	68.00
701	64.00	69.00	94.00	73.00	64.00	64.00
702	57.00	62.00	87.00	68.00	59.00	59.00

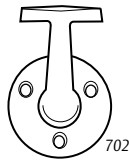

Coat Hooks

Part	3/605	10B/613	10BE/BSP	15/619	15A/620	26D/626	26/625
790	9.70	12.90	25.50		24.20	8.90	10.60
796	10.20	13.90	27.20	14.10	22.50	10.80	8.90
802	11.60	15.10	31.10	14.40	23.70	12.30	9.90
806	12.90	16.60	33.30	16.60	24.90	14.20	11.50

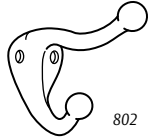
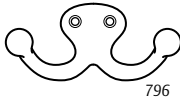

Ball Knob

Part	3/605	10B/613	10BE/BSP	15/619	26D/626	26/625
841	9.40	13.90	21.60	14.20	9.00	9.40



Utility Pull

Part	3/605/4/606	10B/613	10BE/BSP	26/625/26D/626	Burnished Aluminum
845	33.80	36.90	48.30	35.80	13.20

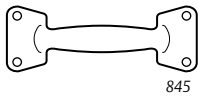

Wire Pulls - Specify Door Thickness

Part	3/605/4/606	10B/613	10BE/BSP	26D/626	26/625	32D/630	32DMS
850	33.70	35.80	36.00	32.10	32.10	29.10	40.50
851	33.70	35.80	36.00	32.10	32.10	29.10	40.50
852	33.70	35.80	36.00	32.10	32.10	29.10	40.50
853	31.70	12.30	27.00	7.60	7.20	7.40	30.60
856-RKW	37.40	38.50	40.90	35.80	35.80	33.80	46.20



Flush Pulls

Part	3/605	10BE/BSP	26D/626	32D/630
860		14.90		6.80
870	5.90	9.90		4.30
872	15.00	32.70	17.00	

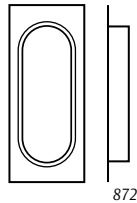

Edge Pulls

Part	3/605	10B/613	10BE/BSP	26D/626	26/625
880	13.60	14.90		13.20	
885-RKW	44.70	51.00	83.00	49.40	51.00

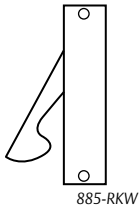

Pocket Door Pulls - For use on 1 3/8" to 1 3/4" Doors

Part	3/605	10B/613	26D/626	26/625
890	13.90	14.90	13.40	13.90
891	14.40	15.70	14.00	14.40

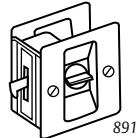

Magnetic Catches

Part	Brass	Aluminum
900	9.00	9.50
901	12.90	13.60

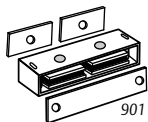

Adjustable Ball Catches

Part	3/605	26D/626
910	9.50	9.40
910RC	14.00	12.60
911	10.00	10.00
911RC	15.30	14.00

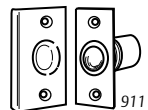

Coordinators

Carry Bar for 2600 Series Coordinators

Part	Black	3/605/4/606	10/612/26D/626	10B/613
1100	54.00	79.00	51.00	79.00

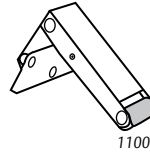

Mounting Brackets (For Soffit Applied Hardware)

Part	Black	28/628
2601AB	19.40	27.50
2601C	19.40	27.50

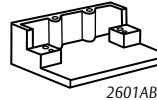

2600 Series Coordinators w/Filler and Filler Bars

NX2648-NX2654	123.00	139.00
2655-2660	133.00	127.00
2661-2672	102.00	127.00
2673-2696	118.00	139.00
L2662-L26112	99.00	207.00
FB-1	37.90	31.20
FB-2	36.40	35.90

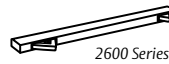

1700 Universal Door Coordinator

1700	109.00	113.00
------	--------	--------



Flush Bolts

Flush Bolts

Part	3/605/4/606/10/612/10B/613	10BE/BSP	26/625	26D/626	32D/630	32/629
2805	78.00	124.00		76.00	76.00	85.00
2840	78.00	124.00	78.00	76.00	76.00	
2842	149.00	236.00	149.00	133.00	134.00	
2845	149.00	236.00	149.00	143.00	145.00	
2848	149.00	236.00			145.00	162.00
2849	149.00	236.00			145.00	162.00
2905	82.00	121.00		79.00	80.00	90.00
2940	82.00	121.00	82.00	79.00	80.00	
2942	160.00	254.00	160.00	143.00	145.00	
2945	160.00	254.00	160.00	155.00	156.00	
2948	160.00	235.00			156.00	175.00
2949	160.00	229.00			156.00	175.00
2960	187.00	276.00			183.00	205.00
2962	187.00	276.00			183.00	205.00
BFB (wood or metal door)					127.00	
CPK 2840	22.50	30.70			21.80	24.50

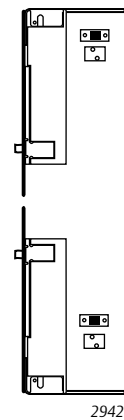
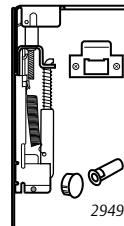

Overhead Holders & Stops

Heavy Duty Concealed		
Part	10B/613	32D/630
OH101S	346.00	322.00
OH102S	346.00	322.00
OH103S	346.00	322.00
OH104S	346.00	322.00
OH105S	346.00	322.00
OH101H	346.00	293.00
OH102H	346.00	293.00
OH103H	346.00	293.00
OH104H	346.00	293.00
OH105H	346.00	293.00
Standard Duty Concealed		
Part	10B/613	32D/630
OH201M	168.00	130.00
OH202M	168.00	130.00
OH203M	168.00	130.00
OH204M	168.00	130.00
OH205M	168.00	130.00
Heavy Duty Surface Mounted		
Part	10B/613	32D/630
OH901S	326.00	287.00
OH902S	326.00	287.00
OH903S	326.00	287.00
OH904S	326.00	287.00
OH905S	326.00	287.00
OH901H	326.00	287.00
OH902H	326.00	287.00
OH903H	326.00	287.00
OH904H	326.00	287.00
OH905H	326.00	287.00
Standard Duty Surface Mounted		
Part	10B/613	32D/630
OH1001M	208.00	142.00
OH1002M	208.00	142.00
OH1003M	208.00	142.00
OH1004M	208.00	142.00
OH1005M	208.00	142.00

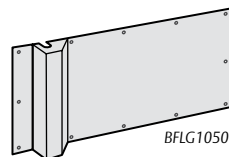
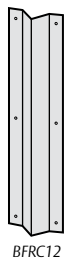
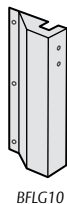
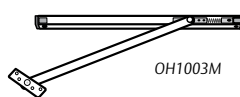
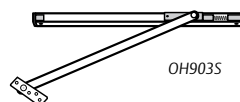
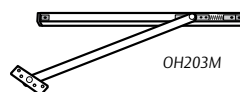
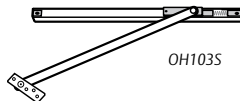

Covers

Latch Guard Covers - .050" Thick (Specify Handing)				
Part	3/605	10B/613	10BE/BSP	32D/630
BFLG10			170.00	128.00
BFLG12			178.00	132.00
BFLG16			196.00	149.00
Vertical Rod Covers - .050" Thick				
Part	3/605	10B/613	10BE/BSP	32D/630
BFRC12	141.00	150.00	135.00	48.30
BFRC24	165.00	165.00	176.00	68.00
Vertical Rod Latch Guard Cover				
Part	Width of Door	10BE/BSP	32D/630	
BFLG1050	Up to 36"	283.00	213.00	

Over 36" add \$1.00/in.

**ASSA ABLOY**  
 Opening Solutions  
 Experience a safer  
 and more open world

Pivots

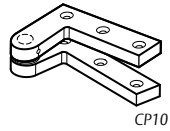

CP10

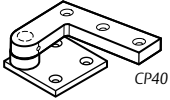

CP40

Standard Head				
Part	3/605 4/606	10/612 10B/613	10BE/BSP	26/625 26D/626
CP10	293.00	321.00	441.00	310.00
CP10HD	425.00	454.00	626.00	440.00
Standard Floor				
CP40	293.00	321.00	441.00	310.00
CP40HD	425.00	454.00	626.00	440.00

Prices are for 1 3/4" thick wood doors. Pivots for thicker doors are priced on application. Allow 4 weeks delivery. NOTE: Pivots are 3/8" x 7/8" wide; HD (heavy duty) pivots are 1/2" x 1" wide.

Order form available when ordering.

Custom Strikes

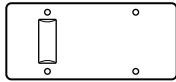

590DA

Custom Strikes					
Part	Quantity	3/605 4/606 10/612 10B/613	10BE/ BSP	26/625 26D/626 32/629	32D/630
CS-ASA1, CS-ASA2, CS-OM, CS-T, 590-DA	Up to 5	59.00	72.00	59.00	46.30
	6 to 10	52.00	65.00	53.00	42.50
	11 to 20	49.40	61.00	49.40	37.00
	21 +	45.70	57.00	46.20	34.30

.090" Thick (\$102.00 minimum charge. Made to your specifications.)

Order form available when ordering.

Filler Plates & Shims



DF86

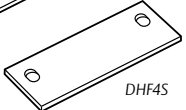

DHF4S

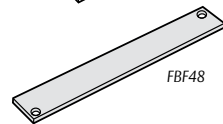

FBFB48

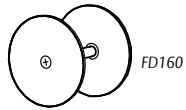

FD160

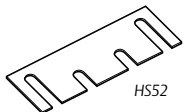

HS52

Filler Plates & Shims			Part	Pack Size	Price
Part	Pack Size	Price	HS54	50	84.00
DF86	25	97.00	LA86	25	173.00
DFF4	25	73.00	LF161	25	65.00
DFF5	25	81.00	SFASA	25	63.00
DHF4B	25	75.00	SF160	25	56.00
DHF4S	25	78.00	SFB160	25	58.00
DHF5B	25	73.00			
DHF5S	25	81.00			
FBFB48	25	86.00			
FBS48	25	51.00			
FC161	25	93.00			
FD160	25	81.00			
HS42	50	65.00			
HS44	50	78.00			
HS52	50	78.00			

Sold in pack quantities only.

Angle Plates

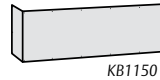

KB1150

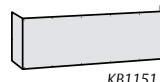

KB1151

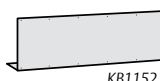

KB1152

Angle Plates		
Part	Description	Pricing
KB1150 Style A	One-Sided	Fax or Email Dimensions for Pricing
KB1151 Style C	Two-Sided	Fax or Email Dimensions for Pricing
KB1152 Style B	Bottom	Fax or Email Dimensions for Pricing

.050" Thick - Refer to page 41 for Angle Plate Fasteners. Add \$37.80 list per bend to plates price.

Order form available when ordering.

Trim Protector Bars

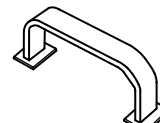

HD2250



R111LPB



R116EDPH



SD1260

Heavy Duty - 3/8" thick stainless for heavy traffic.				
Part	CTC	10BE/ BSP	32D/ 630	32DMS
HD2230	8"	208.00	151.00	203.00
HD2240	8"	208.00	151.00	203.00
HD2250	8"	208.00	151.00	203.00

Lever - 3/8" thick for heavy traffic.					
Part	3/605	10/612 10B/613	10BE/ BSP	32D/ 630	32DMS
R101LPB	249.00	286.00	145.00	101.00	155.00
R102LPB	285.00	350.00	234.00	189.00	228.00
R111LPB	267.00	320.00	150.00	105.00	146.00
R112LPB	299.00	366.00	268.00	219.00	261.00
R115LPB	286.00	339.00	165.00	111.00	161.00

Exit Device - 3/8" thick stainless for heavy traffic. Field cutting hinge end of exit device is required.			
R116EDPL	369.00	282.00	359.00
R116EDPH	369.00	282.00	359.00

Standard Duty - 3/16" thick stainless for moderate traffic.			
SD1230	76.00	54.00	75.00
SD1240	76.00	54.00	75.00
SD1250	76.00	54.00	75.00
SD1260	76.00	54.00	75.00

### Door Plates Hundred Square Inch Size Chart

To calculate the list price of kick plate, use the hundred square inch number times the list price. (Example: 10" x 34" is 3.40 square inches.) Take that number times the list price from the following page. (Example: 32D list \$10.70 x 3.40 = \$36.38)

H/W	24"	26"	28"	30"	32"	34"	36"	38"	40"	42"	44"	46"	48"
4"	0.96	1.04	1.12	1.20	1.28	1.36	1.44	1.52	1.60	1.68	1.76	1.84	1.92
6"	1.44	1.56	1.68	1.80	1.92	2.04	2.16	2.28	2.40	2.52	2.64	2.76	2.88
8"	1.92	2.08	2.24	2.40	2.56	2.72	2.88	3.04	3.20	3.36	3.52	3.68	3.84
10"	2.40	2.60	2.80	3.00	3.20	3.40	3.60	3.80	4.00	4.20	4.40	4.60	4.80
12"	2.88	3.12	3.36	3.60	3.84	4.08	4.32	4.56	4.80	5.04	5.28	5.52	5.76
14"	3.36	3.64	3.92	4.20	4.48	4.76	5.04	5.32	5.60	5.88	6.16	6.44	6.72
16"	3.84	4.16	4.48	4.80	5.12	5.44	5.76	6.08	6.40	6.72	7.04	7.36	7.68
18"	4.32	4.68	5.04	5.40	5.76	6.12	6.48	6.84	7.20	7.56	7.92	8.28	8.64
20"	4.80	5.20	5.60	6.00	6.40	6.80	7.20	7.60	8.00	8.40	8.80	9.20	9.60
22"	5.28	5.72	6.16	6.60	7.04	7.48	7.92	8.36	8.80	9.24	9.68	10.12	10.56
24"	5.76	6.24	6.72	7.20	7.68	8.16	8.64	9.12	9.60	10.08	10.56	11.04	11.52
26"	6.24	6.76	7.28	7.80	8.32	8.84	9.36	9.88	10.40	10.92	11.44	11.96	12.48
28"	6.72	7.28	7.84	8.40	8.96	9.52	10.08	10.64	11.20	11.76	12.32	12.88	13.44
30"	7.20	7.80	8.40	9.00	9.60	10.20	10.80	11.40	12.00	12.60	13.20	13.80	14.40
32"	7.68	8.32	8.96	9.60	10.24	10.88	11.52	12.16	12.80	13.44	14.08	14.72	15.36
34"	8.16	8.84	9.52	10.20	10.88	11.56	12.24	12.92	13.60	14.28	14.96	15.64	16.32
36"	8.64	9.36	10.08	10.80	11.52	12.24	12.96	13.68	14.40	15.12	15.84	16.56	17.28
38"	9.12	9.88	10.64	11.40	12.16	12.92	13.68	14.44	15.20	15.96	16.72	17.48	18.24
40"	9.60	10.40	11.20	12.00	12.80	13.60	14.40	15.20	16.00	16.80	17.60	18.40	19.20
42"	10.08	10.92	11.76	12.60	13.44	14.28	15.12	15.96	16.80	17.64	18.48	19.32	20.16
44"	10.56	11.44	12.32	13.20	14.08	14.96	15.84	16.72	17.60	18.48	19.36	20.24	21.12
46"	11.04	11.96	12.88	13.80	14.72	15.64	16.56	17.48	18.40	19.32	20.24	21.16	22.08
48"	11.52	12.48	13.44	14.40	15.36	16.32	17.28	18.24	19.20	20.16	21.12	22.08	23.04

### Options

Option	Add	12"H or Less	Over 12" - 48"H
<b>HVBEV</b>	Heavy Beveled Edges	7.60	13.00
<b>BEV</b>	Beveled - No charge included on all plates		
<b>CSK</b>	Countersunk Holes	0.55 per hundred square inch	
<b>SA</b>	Self-Adhesive Mount	20.00	41.40
	<b>CFC</b>	43.40	
	Cut for Louver	135.00	
	Notch for Armor	62.00	
	Add Row of Screws	19.50	
	UL Listing	12.70	

Order form available for K1050 for Notch, Cylinder and Louver preps.

### Screw Quantity Chart

Height/Length	17" - 24"	25" - 32"	33" - 40"	41" - 48"
4" - 12"	8 pcs.	10 pcs.	12 pcs.	14 pcs.
13" - 18"	10 pcs.	12 pcs.	14 pcs.	16 pcs.
19" - 24"	12 pcs.	14 pcs.	16 pcs.	18 pcs.
25" - 32"	16 pcs.	18 pcs.	20 pcs.	22 pcs.
33" - 40"	18 pcs.	20 pcs.	22 pcs.	24 pcs.
40" - 48"	20 pcs.	22 pcs.	24 pcs.	26 pcs.

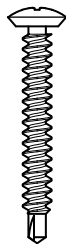

### Cut Installation Time in Half with SELF DRILLING TEK SCREWS

- For US32D Kick Plates SP1050; \$45.65/Hundred Pack.
- For US3 Kick Plates SP1069; \$83.94/Hundred Pack
- Packed with each plate - specify when ordering "by TEK Screws".

Size	Screws Required	US32D 630
8" x 34"	12	2.50
10" x 34"	12	2.50
12" x 34"	12	2.50
16" x 34"	14	2.50
36" x 34"	22	5.00

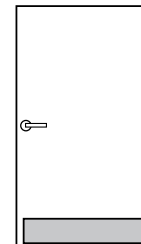

Mop Plate Up to 8"H x 48"W

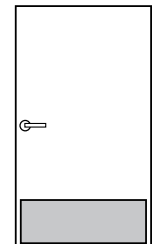

Kick Plate 6" to 12"H x 48"W

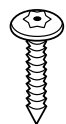

### TORX SECURITY SCREWS

- For US32D Kick Plates SP1042; \$63.00/Hundred Pack.
- Packed with each plate - specify when ordering "by TORX Screws".

Size	Screws Required	US32D 630
8" x 34"	12	8.80
10" x 34"	12	8.80
12" x 34"	12	8.80
16" x 34"	14	8.80
36" x 34"	22	16.00

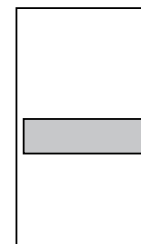

Stretcher Plate 6" to 12"H and up to 48"W

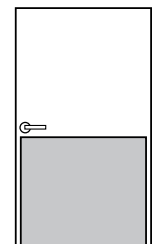

Armor Plate Up to 48"H x 48"W

## ASSA ABLOY

Opening Solutions

Experience a safer and more open world



Price includes bevel edges!

## Door Plates

Finish	Maximum Size	8", 10", 12" Height	4", 6" Special Height <12"	12.1" ≤ 36" High	36.1" ≤ 48" High
K1050					
K1050WS (UL+WS add)					
US32DNF (Nickel Free)	48" x 48"	10.00	12.00	10.20	10.20
US32D	48" x 48"	10.70	12.90	11.10	11.10
US32DMS	48" x 48"	17.60	20.90	17.80	17.80
US32D316	40" x 48"	14.40	17.30	14.90	14.90
US32	48" x 48"	24.20	29.10	24.70	24.70
US3	48" x 48"	34.90	41.30	44.40	53.00
US4	48" x 48"	34.90	41.30	44.40	53.00
US9	48" x 48"	38.90	46.90	49.30	60.00
US10	48" x 48"	41.80	50.00	50.00	61.00
US10B	48" x 48"	39.80	48.40	50.00	61.00
10BE	48" x 48"	17.10	20.40	17.60	17.60
US15	24" x 48"	40.40	48.90		
US26D	24" x 48"	39.80	48.40		
US26	24" x 48"	39.80	48.40		
US5	48" x 48"	39.80	48.40	50.00	61.00
US28	48" x 48"	9.80	11.80	10.20	5.80
K1038					
US32D	48" x 48"	10.70	12.70	10.90	10.90
K1062					
32D	48" x 48"	34.90	34.90	34.90	34.90
32DMS	48" x 48"	37.60	37.60	37.60	37.60
10BE	48" x 48"	38.40	38.40	38.40	38.40
K1125					
US32D	48" x 48"	87.00	87.00	87.00	87.00
US3	48" x 48"	163.00	163.00	163.00	163.00
US4	48" x 48"	163.00	163.00	163.00	163.00
US9	48" x 48"	187.00	187.00	187.00	187.00
US10	48" x 48"	176.00	176.00	176.00	176.00
US10B	48" x 48"	176.00	176.00	176.00	176.00
10BE	48" x 48"	98.00	98.00	98.00	98.00
US28	48" x 48"	47.30	47.30	47.30	47.30
ALM DIA	48" x 48"	48.90	48.90	48.90	48.90
K2125					
Stock Plastic	48" x 48"	27.80	27.80	27.80	27.80
K3125					
Stock Plastic	48" x 48"	12.00	12.00	12.00	12.00
K4125					
Clear Plastic	48" x 48"	12.00	12.00	12.00	12.00
K2060					
Stock Kydex .060"	48" x 48"	13.60	15.60	13.60	13.60

## OTHER OPTIONS

- Countersunk on .050" Metal Plates add \$0.55 per hundred square inch.
- SA - Self Adhesive Kick Plates 12" high & under add \$20.00 each, over 12" high add \$41.40 each (not available on any US10B size or Brass & Bronze Base Plates over 24" high).

## FOR FIRE RATED OPENINGS

- K1050-F\* Screw Mounted Plates for steel fire doors rated up to and including 3 hours and wood composite type fire doors rated up to 1 1/2 hours. Available in US32D and all other metal finishes. **Add \$12.70 per plate.** (Maximum Size: 54"H x 46 1/2"W) **UL Approved.**
- K2060SA-F\* Self-Adhesive Kydex for 90-minute wood door and 3-hour metal door. **Add \$12.70 per plate.** (Maximum Size: 54"H x 46 1/2"W) **UL Approved.**



\* **NFPA 80 STANDARDS — 2-4.5 Protection Plates:** Factory-installed protection plates shall be installed in accordance with the listing of the door. Field-installed protection plates shall be labeled and installed in accordance with their listing. **Exception: Labeling is not required where the top of the protection plate is not more than 16" (406 mm) above the bottom of the door.**

NOTE: Door Plate list pricing is per Hundred Square Inches. Refer to "Hundred Square Inch Size Chart" on page 30 to calculate the list price of each door plate and other available options. See page 41 for special kick plate fasteners.

NOTE: K1050WS plates have a UL and Windstorm rating, add \$25.30 per plate.

**ASSA ABLOY**  
Opening Solutions  
Experience a safer  
and more open world



**K1050-1 - K1050-8 & K1050A-1 - K1050A-8 (.050" Thick) Shaped Metal Plates Add-On Chart**

Add unit price below to list price for kick plate from above chart. Prices are based on same size and same shape.

Pieces	Pricing
1 - 10 Pieces	Email Dimensions and Quantities for Pricing
11 - 20 Pieces	Email Dimensions and Quantities for Pricing
21+ Pieces	Email Dimensions and Quantities for Pricing

To calculate Shapes™ metal plate price use the largest height x width dimension of the size required to make your design. Refer to "Hundred Square Inch Size Chart" on page 30 and the list price for 32D K1050 kick plates above. Then add the per plate charge supplied by the factory.

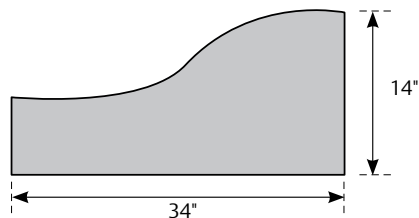

**Example:  
 14" x 34" Plate Calculation**



## Architectural Finishes

Most of Rockwood's products are available in all of the following architectural finishes. The catalog indicates exceptions. This finish list is grouped by base metal.

Base Metal	Description	Price Book Code	Rockwood Code	BHMA Code
Aluminum	Satin	27	US27	627
Aluminum	Clear Anodized	28	US28	628
Aluminum	Light Bronze Anodized	311	311	—
Aluminum	Medium Bronze Anodized	312	312	—
Aluminum	Dark Bronze Anodized	313	313	710
Aluminum	Extra Dark Bronze Anodized	314	314	—
Aluminum	Black Anodized	315	315	711
Aluminum	White Powder Coat	WPC	WPC	—
Aluminum	Red Powder Coat	RPC	RPC	—
Aluminum	Black Powder Coat	BPC	BPC	—
Brass	Polished Clear Coated	3	US3	605
Brass	Polished No Coating	3NL	US3NL	—
Brass	Satin Clear Coated	4	US4	606
Brass	Satin Oxidized Relieved	5	US5	609
Brass	Satin Nickel Plated Clear Coated	15	US15	619
Brass	Satin Nickel Blackened Relieved Clear Coated	15A	US15A	620
Brass	Flat Black Powder Coated	19	US19	622
Brass	Polished Chrome Plated	26	US26	625
Brass	Satin Chrome Plated	26D	US26D	626
Bronze*	Polished Clear Coated	9	US9	611
Bronze*	Satin Clear Coated	10	US10	612
Bronze*	Satin Black Oxidized Oil Rubbed	10A	US10A	722
Bronze*	Satin Oxidized Oil Rubbed	10B	US10B	613
Bronze*	Satin Oxidized Clear Coated	10BL	US10BL	614
Bronze*	Dark Oxidized Statuary Clear Coated	20A	US20A	624
Stainless Steel	Polished	32	US32	629
Stainless Steel	Satin	32D	US32D	630
<b>Special Finishes</b> (see descriptions)				
Stainless Steel	Satin MicroShield® Coated	32DMS***	US32DMS***	—
Stainless Steel	Polished 316 Alloy	32316***	US32316***	—
Stainless Steel	Satin 316 Alloy	32D316***	US32D316***	—
	Dark Oxidized Satin Bronze, Equivalent	10BE	US10BE	(613E)
	Black Suede Powder Coat	BSP	BSP	—
	White Suede Powder Coat	WSP	WSP	—
	Wrought Black Powder Coat	WB	WB	—

## Special Finishes Description

**32DMS** (MicroShield®): As part of its promise to provide innovative solutions to their customers, ASSA ABLOY Group companies offer the MicroShield® technology, a silver-based antimicrobial coating designed to inhibit the spread of germs and bacteria.

**32316** and **32D316** are made from alloy 316 stainless steel containing molybdenum and extra nickel giving it substantially higher corrosion resistance than the standard stainless steels typically used in door hardware. This finish is ideal for use in coastal, urban, and industrial areas that have harsh environmental conditions. **32316** (polish) finishes offer the best corrosion resistance and should be used in caustic environments.

**10BE** Dark Oxidized Satin Bronze equivalent: This finish provides the richness and warmth of the 10B/613 "living" finish, but maintains its original color and appearance and will not fade or wear over time. The 10BE finish is offered by Corbin Russwin, McKinney, Norton, Rixson, Rockwood, SARGENT and Yale, providing visual consistency between ASSA ABLOY Group brands.

\* On most bronze finishes we will supply solid bronze material. Where solid bronze material is not available, we will use brass as a base material with a bronze look powder coat in its place.  
\*\*\* Available on select items as indicated by the finish icon throughout the catalog.



MicroShield® is a registered trademark of Yale Security Inc., an ASSA ABLOY Group company.

### Set Mounting Charges

Mounting Spec #	Door Type	Pull Type	Mounting Type			Add On
			Pull Free End	Push Free End	Common End	
T1	Metal & Wood	Straight or Offset	12	12	5	32.84
T1HD	Metal & Wood	Straight or Offset	12HD	12HD	5HD	40.11
T2	Glass	Straight or Offset	15	15	13	41.61
T2HD	Glass	Straight or Offset	15HD	15HD	13HD	49.94
T3*	Metal & Wood	Straight or Offset	1	1	5	Included
T3HD	Metal & Wood	Straight or Offset	1HD	1HD	5HD	14.82
T4	Metal	Straight	6	6	5	12.74
T4HD	Metal	Straight	6HD	6HD	5HD	18.98
T4	Metal	Offset	17	17	16	18.96
T4HD	Metal	Offset	17HD	17HD	16HD	23.33
T5	Wood	Straight or Offset	8	8	5	15.37

\*T3 is the standard mounting method for Metal and Wood Doors.

NOTE: Heavy Duty (HD) mounting features hex drive for positive tightening and large overall size for superior strength. Recommended for high frequency and rough service openings.

### Mounting Types

Pull Style	PULL ON ONE SIDE OF DOOR								PULL ON BOTH SIDES OF DOOR (BTB)				
	Thru Bolt	Deco Thru Bolt	Concealed						Conehead/Set Screw				Lug Plate
Door Type	Wood/Metal	Glass	Metal	Metal	Wood	Metal	Metal	Wood/Metal	Glass		Any		
Coneheads	NA	NA	NA	Single	Single	Single	Double	Single	Double	Single	Double	Single	
Mounting Type	Type 1	Type 12	Type 15	Type 6	Type 6R	Type 8	Type 17	Type 17R	Type 5	Type 16	Type 13	Type 18	Type 9
Standard (STD) Bolt Size	1/4"-20	1/4"-20	1/4"-20	1/4"-20	1/4"-20	1/4"-20	1/4"-20	1/4"-20	1/4"-20	1/4"-20	1/4"-20	1/4"-20	1/4"-20
Price	INCL	28.59	33.78	8.49	13.39	11.12	12.65	17.87	8.49	12.62	15.65	21.67	28.06
Heavy Duty (HD) Bolt Size	5/16"-18	5/16"-18	5/16"-18	5/16"-18	5/16"-18	5/16"-18	5/16"-18	5/16"-18	5/16"-18	5/16"-18	5/16"-18	5/16"-18	
Price	8.49	33.78	40.03	12.65	18.95	15.55	15.55	22.35	12.65	15.55	19.81	24.78	
Extra Heavy Duty (XHD) Bolt Size	3/8"-16	3/8"-16	3/8"-16										
Price	12.42	36.90	43.15										

Straight Pulls														
Pull Type	Dia.	MAXIMUM BOLT SIZE ALLOWED								MAXIMUM BOLT SIZE ALLOWED				
		Type 1	Type 12	Type 15	Type 6	Type 6R	Type 8	Type 17	Type 17R	Type 5	Type 16	Type 13	Type 18	Type 9
Straight	5/8"	STD	STD	STD			STD					STD		
Straight	3/4"	HD	HD	HD	STD		STD					STD		STD
Straight	1"	HD	HD	HD	HD	HD	HD					HD		STD

Offset Pulls														
Pull Type	Dia.	MAXIMUM BOLT SIZE ALLOWED								MAXIMUM BOLT SIZE ALLOWED				
		Type 1	Type 12	Type 15	Type 6	Type 6R	Type 8	Type 17	Type 17R	Type 5	Type 16	Type 13	Type 18	Type 9
Offset	5/8"	STD	STD	STD								STD		
Offset	3/4"	HD	HD	HD								STD		
Offset	1"	XHD	XHD	XHD				HD	STD		HD	HD		
Offset	1 1/4"	XHD	XHD	XHD				HD	STD		HD	HD		

NOTE: Heavy Duty (HD) mounting features hex drive for positive tightening and large overall size for superior strength. Recommended for high frequency and rough service openings.

**Free End Thru Bolt**

**TYPE 1 - Thru Bolt Wood or Metal Door**

Labels: Pull, Finish Washer, Flat Head Machine Screw, Outside, Inside

Type	Bolt Size	Drill Size	Price
1	1/4"-20	9/32	Incl.
1HD	5/16"-18	11/32	8.49
1XHD	3/8"-16	13/32	12.42

**TYPE 12 - Decorative Thru Bolt Wood or Metal Door**

Labels: Pull, Thru Bolt

Type	Bolt Size	Drill Size	Price
12	1/4"-20	9/32	28.59
12HD	5/16"-18	11/32	33.78
12XHD	3/8"-16	13/32	36.90

**TYPE 15 - Decorative Thru Bolt Glass Door**

Labels: Plastic Washers, Pull, Thru Bolt, Neoprene Bushing 5/8" Dia. Hole

Type	Bolt Size	Drill Size	Price
15	1/4"-20	5/8	33.78
15HD	5/16"-18	5/8	40.03
15XHD	3/8"-16	5/8	43.15

**Free End Concealed**

**TYPE 6 - Surface Concealed Metal Door**

Minimum diameter of pull is 5/8"

Labels: Cone Head Machine Screw, Pull, Set Screw, Reinforcement by others

For doors with rivnuts specify Type 6R

Type	Bolt Size	Drill Size	Price
6	1/4"-20	1/4"-20 Tap	8.49
*6HD	5/16"-18	5/16"-18 Tap	12.65

**TYPE 6R - Surface Concealed Metal Door**

Minimum diameter of pull is 1"

Labels: Cone Head Machine Screw, Pull, Set Screw, Rivnut

Type	Bolt Size	Drill Size	Price
6R	1/4"-20	N/A	13.39
*6RHD	5/16"-18	N/A	18.95

**TYPE 8 - Surface Concealed Wood Door**

Labels: Cone Head Machine Screw, Pull, Knife Thread Insert, 1/4"-20 Set Screw

Type	Bolt Size	Drill Size	Price
8	1/4"-20	23/64-9/16 dp.	11.12
*8HD	5/16"-18	7/16-9/16 dp.	15.55

**TYPE 17 - Surface Concealed Metal Door**

Minimum diameter of pull is 1"

Labels: Cone Head Machine Screw, Pull, Set Screws, Reinforcement by others

Type	Bolt Size	Drill Size	Price
17	1/4"-20	1/4"-20 Tap	12.65
17HD	5/16"-18	5/16"-18 Tap	15.55

**TYPE 17R - Surface Concealed Metal Door**

Minimum diameter of pull is 1"

Labels: Cone Head Machine Screw, Pull, Set Screws, Rivnut

Type	Bolt Size	Drill Size	Price
17R	1/4"-20	N/A	17.87
17RHD	5/16"-18	N/A	22.35

\*HD mountings feature 2 set screws 180° apart.

NOTE: Y base plates are recommended on wood or glass doors to make a stable and durable mounting (see page 40 for details).  
 NOTE: Heavy Duty (HD) mounting features hex drive for positive tightening and large overall size for superior strength.  
 Recommended for high frequency and rough service openings.

**Flush Pull Mounting**

Type 10 Mounting applies to the 94 Series Flush Pulls

**TYPE 10 - Surface Mounted Wood or Metal Door**

Type	Bolt Size	Drill Size	Price
10	#8-32	9/32	15.55

**Wire or Small Post Mount Pull Mounting**

NOTE: This mounting should only be used on pulls with mounting points that are 1/2" in diameter.

**TYPE 55 - Back-to-Back Wood or Metal Door**

Type	Bolt Size	Drill Size	Price
55	#8-32	13/64	15.55

**Common End Back-to-Back**

**TYPE 5 - Back-to-Back Wood or Metal Door**  
 Minimum diameter of pull is 5/8"

Type	Bolt Size	Drill Size	Price
5	1/4"-20	9/32	8.49
5HD	5/16"-18	11/32	12.65

**TYPE 9 - Back-to-Back w/Lug Plate Any Door Type**  
 Minimum diameter of pull is 5/8"

Type	Bolt Size	Drill Size	Price
9	1/4"-20	N/A	28.06

**TYPE 11XHD - Back-to-Back w/Spanner Collar - Wood or Metal Door**  
 Minimum diameter of pull is 1"

Type	Bolt Size	Drill Size	Price
11XHD	3/8"-16	13/32	32.23

**TYPE 13 - Back-to-Back Glass Door**

Type	Bolt Size	Drill Size	Price
13	1/4"-20	5/8	15.65
*13HD	5/16"-18	5/8	19.81

**TYPE 14XHD - Back-to-Back Glass Door**  
 Minimum diameter of pull is 1"

Type	Bolt Size	Drill Size	Price
14XHD	3/8"-16	5/8	38.46

**TYPE 16 - Back-to-Back Wood or Metal Door**  
 1" diameter offset pulls only

Type	Bolt Size	Drill Size	Price
16	1/4"-20	9/32	12.62
16HD	5/16"-18	11/32	15.55

**TYPE 18 - Back-to-Back Glass Door**

Type	Bolt Size	Drill Size	Price
18	1/4"-20	5/8	21.67
18HD	5/16"-18	5/8	24.78

\*HD mountings feature 2 set screws 180° apart.

## Push and Pull Bar Mounting Details

### Sizing of Push Bars

#### Flush Doors

- Door width: • minus 5" for bent end bars  
 • minus 5" for square end post mount bars  
 • minus 7" for round end post mount bars

#### Stile and Rail Doors or Doors with Lites

- Door width: • minus width of one stile

CAUTION: Always confirm bars will not interfere with jamb or cause pinching hazard.

CAUTION: On narrow stile doors, be sure push bar base fits on the stile and bar does not interfere with the stop.

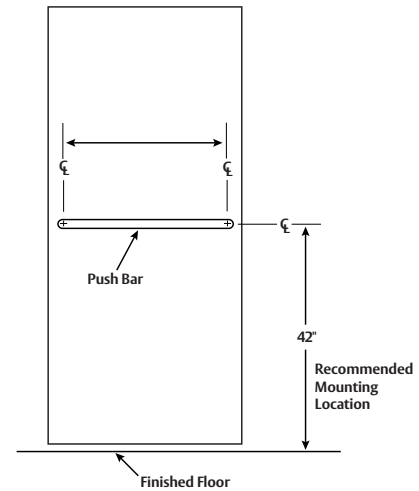

### Handing of Doors

The handing of a door is determined from the outside of the opening.

Standing outside the door:

- If the hinges are on the right, it is a right hand door.
- If the hinges are on the left, it is a left hand door.
- If the door opens away from you, it is a regular bevel door.
- If the door opens toward you, it is a reverse bevel door.

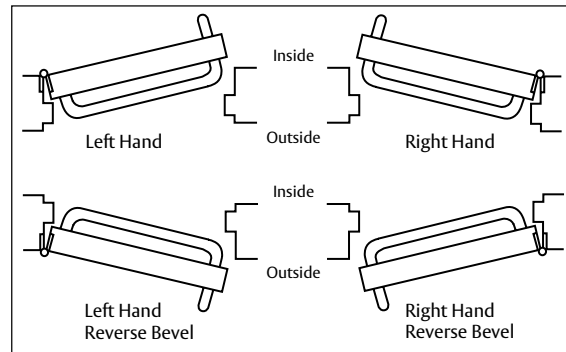

#### TYPICAL MOUNTING

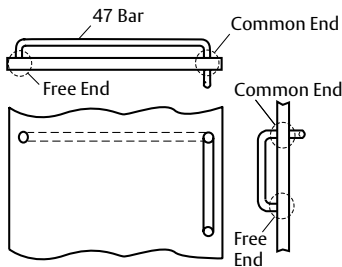

## Thru Bolt Mounting - For 1 3/4" Wood and Metal Doors

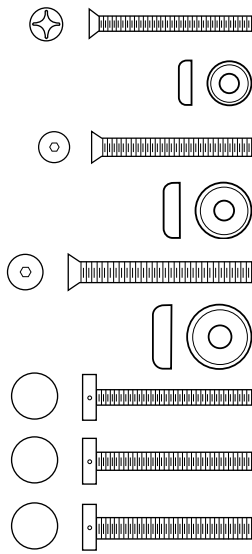

Part	Description	Mounting Type	Price
SP1004	1/4"-20 x 2 1/4" Flat Head Machine Screw Thru Bolt	1	1.26
SP1005	1/4"-20 Finishing Washer	1	0.89
SP1053	5/16"-18 x 2 1/2" Socket Flat Head Machine Screw Thru Bolt	1HD	3.43
SP1054	5/16"-18 Finishing Washer	1HD	1.27
SP1001	3/8"-16 x 2 1/2" Socket Flat Head Machine Screw Thru Bolt	1XHD	5.31
SP1002	3/8"-16 Finishing Washer	1XHD	1.59
SP1003	1" Diameter Decorative Thru Bolt 1/4"-20 x 2 1/4"	12	14.37
SP1055	1" Diameter Decorative Thru Bolt 5/16"-18 x 2 1/4"	12HD	17.12
SP1041	1 1/4" Diameter Decorative Thru Bolt 3/8"-16 x 2 1/4"	12XHD	17.12

## Back-to-Back Mounting - For 1 3/4" Wood and Metal Doors

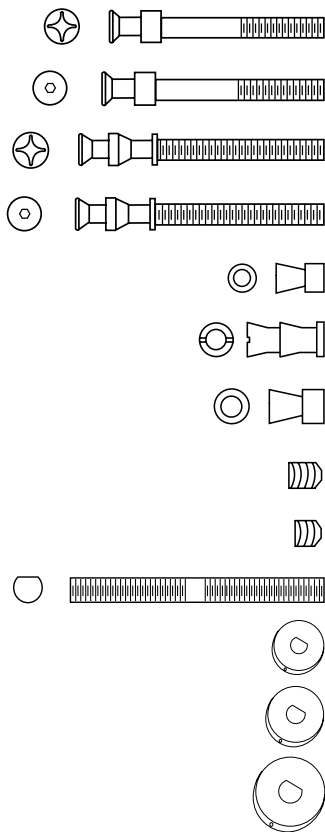

Part	Description	Mounting Type	Price
SP1025	1/4"-20 x 2 1/4" Cone Head Machine Screw	5	3.73
SP1056	5/16"-18 x 2 1/4" Cone Head Machine Screw	5HD	5.90
SP1052	1/4"-20 x 2 1/4" Double Cone Head Machine Screw (for use with offset pulls)	16	4.42
SP1057	5/16"-18 x 2 1/4" Double Cone Head Machine Screw (for use with offset pulls)	16HD	7.26
SP1027	1/4"-20 Cone Head Union (Used to Convert Cone Head to Thru Bolt Hole)	N/A	3.73
SP1079	1/4"-20 Double Cone Head Union (Used to Convert Double Cone Head to Thru Bolt Hole)	N/A	6.58
SP1068	5/16"-18 Cone Head Union (Used to Convert Cone Head to Thru Bolt Hole)	N/A	5.90
SP1026	1/4"-20 x 5/16" Set Screws (Standard)	N/A	0.89
SP1065	1/4"-20 x 3/16" Set Screw (Short)	N/A	1.16
SP1032	3/8"-16 x 3 1/2" LH/RH Bolt	11	7.79
SP1071	Spanner Collar 1" Diameter for LH/RH Bolt	11	11.78
SP1033	Spanner Collar 1 1/4" Diameter for LH/RH Bolt	11	11.78
SP1072	Spanner Collar 1 1/2" Diameter for LH/RH Bolt	11	13.11

### Concealed Mounting - For 1 3/4" Wood and Metal Doors

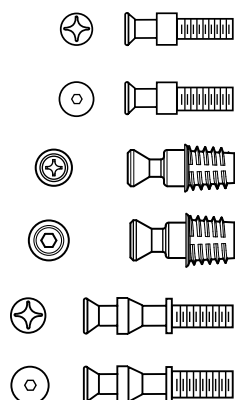

Part	Description	Mounting Type	Price
SP1039	1/4"-20 x 1/2" Cone Head Machine Screw	6 / 6R	3.73
SP1058	5/16"-18 x 1/2" Cone Head Machine Screw	6HD	5.90
SP1080	1/4"-20 Cone Head / Knife Thread Insert	8	6.21
SP1082	5/16"-18 Cone Head / Knife Thread Insert	8HD	6.21
SP1051	1/4"-20 x 1/2" Double Cone Head Machine Screw	17 / 17R	5.90
SP1059	5/16"-18 x 1/2" Double Cone Head Machine Screw	17HD	7.26

### Bushings & Washers - For 1/2" Glass Doors

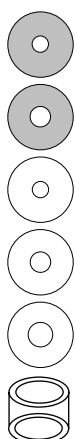

Part	Description	Mounting Type	Price
SP1022	Stainless Steel Washer for 1/4"-20 Cone Head Machine Screw .032" Thick	13	1.59
SP1060	Stainless Steel Washer for 5/16"-18 Cone Head Machine Screw .060" Thick	13HD	1.59
SP1023	Plastic Washer for 1/4"-20 Bolt; Specify Size	13	1.37
SP1061	Plastic Washer for 5/16"-18 Bolt; Specify Size	13HD	1.47
SP1062	Plastic Washer for 3/8"-16 Bolt; Specify Size	14	1.47
SP1024	Glass Door Bushing for 5/8" Hole in Glass; Specify Size	13 / 13HD / 14	1.59

### Thru Bolt Mounting - For 1/2" Glass Doors

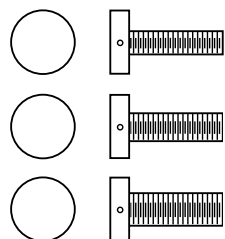

Part	Description	Mounting Type	Price
SP1020	1" Diameter Decorative Thru Bolt; 1/4"-20 x 1 1/8"	15	14.37
SP1063	1" Diameter Decorative Thru Bolt; 5/16"-18 x 1 1/8"	15HD	17.12
SP1040	1 1/4" Diameter Decorative Thru Bolt; 3/8"-16 x 1 1/8"	15XHD	17.12

### Back-to-Back Mounting - For 1/2" Glass Doors

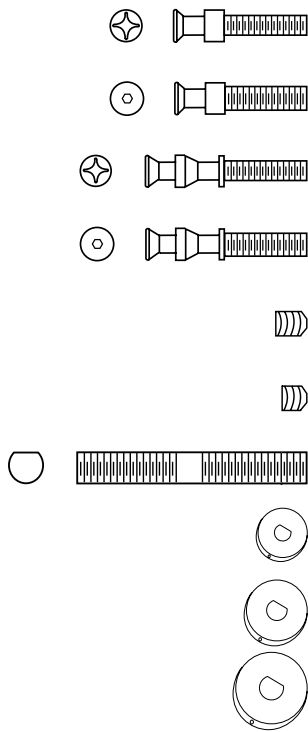

Part	Description	Mounting Type	Price
SP1021	1/4"-20 x 1 1/8" Cone Head Machine Screw	13	3.73
SP1064	5/16"-18 x 1 1/8" Cone Head Machine Screw	13HD	5.90
SP1067	1/4"-20 x 1 1/8" Double Cone Head Machine Screw	18	5.90
SP1066	5/16"-18 x 1 1/8" Double Cone Head Machine Screw	18HD	7.26
SP1026	1/4"-20 x 5/16" Set Screw (Standard)	N/A	0.89
SP1065	1/4"-20 x 3/16" Set Screw (Short)	N/A	1.16
SP1031	3/8"-16 x 1 3/4" LH/RH Bolt (If SP1031 is ordered and KIT14 is not called out fastener will be 2 1/4")	14	7.79
SP1071	Spanner Collar 1" Diameter for LH/RH Bolt	14	11.78
SP1033	Spanner Collar 1 1/4" Diameter for LH/RH Bolt	14	11.78
SP1072	Spanner Collar 1 1/2" Diameter for LH/RH Bolt	14	13.11

### Y Base Plates

Specify bolt hole size and finish. Standard pulls require two plates.

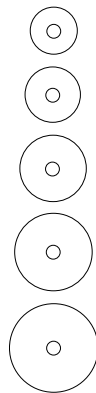

Part	Description	For Use With	Price
SP1073	1/8" Thick x 1 1/16" Diameter	3/4" Diameter Pulls	14.37
SP1074	1/8" Thick x 1 1/4" Diameter	1" Diameter Pulls and Posts	14.37
SP1075	1/8" Thick x 1 1/2" Diameter	1" Diameter Pulls and Posts	14.37
SP1076	1/8" Thick x 1 3/4" Diameter	1" Diameter Pulls and Posts	14.37
SP1077	1/8" Thick x 2" Diameter	1" Diameter Pulls and Posts	14.37

### Flush Pull Fasteners

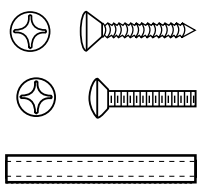

Part	Description	Door Type	Price
SP1006	#8 x 3/4" Oval Head Sheet Metal Screw	Wood or Metal	0.68
SP1007	#8-32 x 3/4" Oval Head Machine Screw	Metal	0.68
SP1034	#8-32 x 1 5/8" Brass Sleeve Machine Screw	Wood or Metal	3.96



### Plate Fasteners

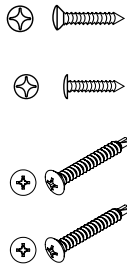

Part	Description	For Use With	Price
SP1008	#6 x 5/8" Oval Head Sheet Metal Screw	Push and Pull Plates; Kick Plates	18.20/c
SP1009	#6 x 3/4" Truss Head Sheet Metal Screw	Plastic / Laminate Kick Plates	18.20/c
SP1050	#6 x 5/8" Oval Head (TEK) Self-Drilling Screw - Stainless Steel	Stainless Steel Kick Plates	45.70/c
SP1069	#6 x 5/8" Oval Head (TEK) Self-Drilling Screw - Brass Painted	Brass Kick Plates	84.00/c

### Sex Nuts

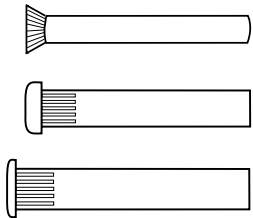

Part	Description	For Use With	Price
SP1018	#8-32 Flat Head Sex Nut	<b>94</b> Series Flush Pulls	5.30
SP1019	#10-24 x 1 9/16" Sex Nut	<b>580</b> Surface Bolts	3.10
SP1070	1/4"-20 x 1 9/16" Sex Nut	<b>585</b> Surface Bolts	7.20

### Tamperproof Torx® Head Security Fasteners

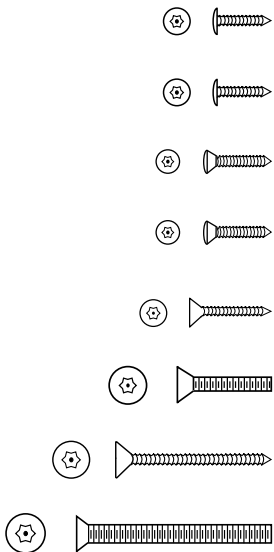

Part	Description	For Use With	Price
SP1016	#6 x 1/2" Button Head Sheet Metal Screw	Plastic Plates	0.90
SP1016B	#6 x 1/2" Button Head Sheet Metal Screw Brass Plated	Kick Plates	2.50
SP1042	#6 x 5/8" Oval Head Sheet Metal Screw	Kick Plates and Push/Pull Plates (Stainless Steel)	0.90
SP1042B	#6 x 5/8" Oval Head Sheet Metal Screw Brass Plated	Kick Plates and Push/Pull Plates	3.30
SP1017	#8 x 3/4" Flat Head Sheet Metal Screw	<b>94</b> Flush Pulls, <b>131</b> Door Pulls, and <b>555</b> Flush Bolts	2.10
SP1035	#8-32 x 3/4" Flat Head Machine Screw	<b>94</b> Flush Pulls, <b>131</b> Door Pulls, and <b>555</b> Flush Bolts	2.30
SP1037	#12 x 1 1/2" Flat Head Wood Screw	<b>440/442</b> Door Stops	2.50
SP1038	1/4"-20 x 2 1/2" Flat Head Machine Screw	Door Pulls Type 1 Mount	3.90

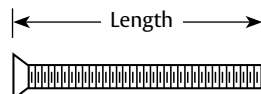

Standard Thru Bolt for Countersunk Holes

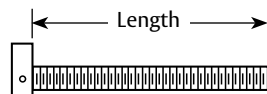

Decorative Thru Bolt for Wood or Metal Doors

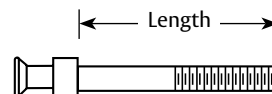

Cone Head Bolt for Back-to-Back Wood or Metal Doors

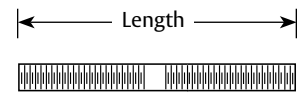

LH/RH Bolt without Heads

**Mounting Kits for Door Pulls**

Part	Mounting Type	Description	Price
<b>KIT1</b>	1	2 ea. 1/4"-20 x 2 1/4" Thru Bolts and 2 ea. Finish Washers; Specify Finish	4.25
<b>KIT1HD</b>	1HD	2 ea. 5/16"-18 x 2 1/2" Thru Bolts and 2 ea. Finish Washers; Specify Finish	8.49
<b>KIT1XHD</b>	1XHD	2 ea. 3/8"-16 x 2 1/2" Thru Bolts and 2 ea. Finish Washers; Specify Finish	12.42
<b>KIT5</b>	5	2 ea. 1/4"-20 x 2 1/4" Cone Head Bolts and 4 ea. Set Screws	8.49
<b>KIT5HD</b>	5HD	2 ea. 5/16"-18 x 2 1/4" Cone Head Bolts and 4 ea. Set Screws	12.65
<b>KIT6</b>	6	2 ea. 1/4"-20 x 1 1/2" Cone Head Bolts and 4 ea. Set Screws	8.49
<b>KIT6HD</b>	6HD	2 ea. 5/16"-18 x 1 1/2" Cone Head Bolts and 4 ea. Set Screws	12.65
<b>KIT11</b>	11	2 ea. 3/8"-16 x 3 1/2" LH/RH Bolt and 2 ea. Spanner Collars for 1 3/4" Doors; Specify Pull Diameter and Finish	32.23
<b>KIT12-1</b>	12	2 ea. 1/4"-20 x 2 1/4" Decorative Thru Bolts; 1" Dia.; Specify Finish	28.59
<b>KIT12-1HD</b>	12HD	2 ea. 5/16"-18 x 2 1/4" Decorative Thru Bolts; 1" Dia.; Specify Finish	33.78
<b>KIT12-1.25XHD</b>	12XHD	2 ea. 3/8"-16 x 2 1/4" Decorative Thru Bolts; 1 1/4" Dia.; Specify Finish	36.90
<b>KIT12-1.5XHD</b>	12XHD	2 ea. 3/8"-16 x 2 1/4" Decorative Thru Bolts; 1 1/2" Dia.; Specify Finish	43.30
<b>KIT13</b>	13	2 ea. 1/4"-20 x 1 1/8" Cone Head Bolts; 2 ea. Metal Washers; 4 ea. Plastic Washers; 2 ea. Bushings for 1/2" Glass Doors; 4 ea. Set Screws; Specify if other than 1/2" Glass	15.65
<b>KIT13HD</b>	13HD	2 ea. 5/16"-18 x 1 1/8" Cone Head Bolts; 2 ea. Metal Washers; 4 ea. Plastic Washers; 2 ea. Bushings for 1/2" Glass Doors; 4 ea. Set Screws; Specify if other than 1/2" Glass	19.81
<b>KIT14</b>	14	2 ea. 3/8"-16 x 2 1/4" LH/RH Bolt; 2 ea. Spanner Collars; 2 ea. Bushings; 4 ea. Washers for 1/2" Glass Doors; Specify Pull Diameter and Finish	38.46
<b>KIT15</b>	15	2 ea. 1/4"-20 x 1 1/8" Decorative Thru Bolts; 1" Dia.; 2 ea. Bushings; 4 ea. Plastic Washers; Specify Finish and Glass Thickness/Hole Size	33.78
<b>KIT15HD</b>	15HD	2 ea. 5/16"-18 x 1 1/8" Decorative Thru Bolts; 1" Dia.; 2 ea. Bushings; 4 ea. Plastic Washers; Specify Finish and Glass Thickness/Hole Size	40.03
<b>KIT15-1.25XHD</b>	15XHD	2 ea. 3/8"-16 x 1 1/8" Decorative Thru Bolts; 1 1/4" Dia.; 2 ea. Bushings; 4 ea. Plastic Washers; Specify Finish and Glass Thickness/Hole Size	43.15
<b>KIT15-1.5XHD</b>	15XHD	2 ea. 3/8"-16 x 1 1/8" Decorative Thru Bolts; 1 1/2" Dia.; 2 ea. Bushings; 4 ea. Plastic Washers; Specify Finish and Glass Thickness/Hole Size	49.37
<b>KIT16</b>	16	2 ea. 1/4"-20 x 2 1/4" Double Cone Head Bolts and 4 ea. Set Screws	12.65
<b>KIT16HD</b>	16HD	2 ea. 5/16"-18 x 2 1/4" Double Cone Head Bolts and 4 ea. Set Screws	15.65

Part	Mounting Type	Description	Price
<b>KIT17</b>	17	2 ea. 1/4"-20 x 1 1/2" Double Cone Head Bolts and 4 ea. Set Screws	12.65
<b>KIT17HD</b>	17HD	2 ea. 5/16"-18 x 1 1/2" Double Cone Head Bolts and 4 ea. Set Screws	15.56
<b>KIT18</b>	18	2 ea. 1/4"-20 x 1 1/8" Double Cone Head Bolts; 2 ea. Metal Washers; 4 ea. Plastic Washers; 2 ea. Bushings for 1/2" Glass Doors; Specify if other than 1/2" Glass and 4 ea. Set Screws	21.67
<b>KIT18HD</b>	18HD	2 ea. 5/16"-18 x 1 1/8" Double Cone Head Bolts; 2 ea. Metal Washers; 4 ea. Plastic Washers; 2 ea. Bushings for 1/2" Glass Doors; Specify if other than 1/2" Glass and 4 ea. Set Screws	24.78
<b>KIT-T1</b>	T1	1 ea. 1/4"-20 x 2 1/4" Cone Head Bolt; 1 ea. 1/4"-20 Cone Head Union; 2 ea. Set Screws; 2 ea. 1/4"-20 x 2 1/4" — 1" Dia. Decorative Thru Bolts; Specify Finish	36.89
<b>KIT-T2</b>	T2	1 ea. 1/4"-20 x 1 1/8" Cone Head Bolt; 1 ea. 1/4"-20 Cone Head Union; 2 ea. Set Screws; 2 ea. 1/4"-20 x 1 1/8" — 1" Dia. Decorative Thru Bolts; 1 ea. Metal Washer; 6 ea. Plastic Washers; 3 ea. Bushings; Specify Finish	46.26
<b>KIT-T3</b>	T3	1 ea. 1/4"-20 x 2 1/4" Cone Head Bolt; 1 ea. 1/4"-20 Cone Head Union; 2 ea. Set Screws; 2 ea. 1/4"-20 x 2 1/4" Thru Bolts; 2 ea. Finish Washers; Specify Finish	12.63
<b>KIT-T4</b>	T4	1 ea. 1/4"-20 x 2 1/4" Cone Head Bolt; 2 ea. 1/4"-20 x 1 1/2" Cone Head Bolts; 3 ea. Set Screws	12.63
<b>KIT-T5</b>	T5	1 ea. 1/4"-20 x 2 1/4" Cone Head Bolt; 2 ea. 1/4"-20 x 1 1/2" Cone Head Wood Screws; 3 ea. Set Screws	12.63
<b>KITRM1.25</b>	11x1XHD	2 ea. 3/8"-16 x 2 1/2" Thru-Bolts; 2 ea. Finish Washers; 1 ea. 3/8"-16 x 3 1/2" LH/RH Bolt; 1 ea. 1 1/4" Spanner Collar; Specify Finish	28.59
<b>KITRM360</b>	11x12XHD	2 ea. 3/8"-16 x 2 1/4" Decorative Thru Bolts 1 1/4" Dia.; 1 ea. 3/8"-16 x 3 1/2" LH/RH Bolt; 1 ea. 1 1/4" Spanner Collar; Specify Finish	53.01
<b>KITRM360G</b>	14x15XHD	2 ea. 3/8"-16 x 2 1/4" Decorative Thru Bolts 1 1/4" Dia.; 1 ea. 3/8"-16 x 2 1/4" LH/RH Bolt; 1 ea. 1 1/4" Spanner Collar; 3 ea. Bushings; 6 ea. Plastic Washers; Specify Finish	62.38
<b>KITRM1.5</b>	11x1XHD	2 ea. 3/8"-16 x 2 1/2" Thru Bolts; 2 ea. Finish Washers; 1 ea. 3/8"-16 x 3 1/2" LH/RH Bolt; 1 ea. 1 1/2" Spanner Collar; Specify Finish	31.70
<b>KITRM380</b>	11x12XHD	2 ea. 3/8"-16 x 2 1/4" Decorative Thru Bolts 1 1/2" Dia.; 1 ea. 3/8"-16 x 3 1/2" LH/RH Bolt; 1 ea. 1 1/2" Spanner Collar; Specify Finish	62.38
<b>KITRM380G</b>	14x15XHD	2 ea. 3/8"-16 x 2 1/4" Decorative Thru Bolts 1 1/2" Dia.; 1 ea. 3/8"-16 x 1 1/4" LH/RH Bolt; 1 ea. 1 1/2" Spanner Collar; 3 ea. Bushings; 6 ea. Plastic Washers; Specify Finish	71.73

**ASSA ABLOY**  
 Opening Solutions  
 Experience a safer  
 and more open world

## Notes

---

The ASSA ABLOY Group is the global leader in access solutions. Every day we help people feel safe, secure and experience a more open world.

**ASSA ABLOY**  
Opening Solutions



ASSA ABLOY Opening Solutions  
Architectural Accessories Group  
Rockwood, PA  
P: 800.458.2424 • F: 800.922.9212  
[www.assaabloydooraccessories.us](http://www.assaabloydooraccessories.us)

(In Canada)  
Door Security Solutions Canada  
160 Four Valley Drive  
Vaughan, ON L4K 4T9  
P: 800.461.3007  
[www.assaabloydss.ca](http://www.assaabloydss.ca)